

SIEMENS



SIPART PS2

Smart Valve Positioner

Venting Gauge Block

Installation Instructions

Edition

12/2014

Answers for industry.

SIPART PS2

Smart Valve Positioner Venting Gauge Block Installation Instructions

Hardware Installation Manual

Introduction

1

Safety notes

2

Installing/mounting

3

Service and maintenance

4

Dimension drawings

5

Legal information

Warning notice system

This manual contains notices you have to observe in order to ensure your personal safety, as well as to prevent damage to property. The notices referring to your personal safety are highlighted in the manual by a safety alert symbol, notices referring only to property damage have no safety alert symbol. These notices shown below are graded according to the degree of danger.

 DANGER
indicates that death or severe personal injury will result if proper precautions are not taken.

 WARNING
indicates that death or severe personal injury may result if proper precautions are not taken.

 CAUTION
indicates that minor personal injury can result if proper precautions are not taken.

NOTICE
indicates that property damage can result if proper precautions are not taken.

If more than one degree of danger is present, the warning notice representing the highest degree of danger will be used. A notice warning of injury to persons with a safety alert symbol may also include a warning relating to property damage.

Qualified Personnel

The product/system described in this documentation may be operated only by **personnel qualified** for the specific task in accordance with the relevant documentation, in particular its warning notices and safety instructions. Qualified personnel are those who, based on their training and experience, are capable of identifying risks and avoiding potential hazards when working with these products/systems.

Proper use of Siemens products

Note the following:

 WARNING
Siemens products may only be used for the applications described in the catalog and in the relevant technical documentation. If products and components from other manufacturers are used, these must be recommended or approved by Siemens. Proper transport, storage, installation, assembly, commissioning, operation and maintenance are required to ensure that the products operate safely and without any problems. The permissible ambient conditions must be complied with. The information in the relevant documentation must be observed.

Trademarks

All names identified by ® are registered trademarks of Siemens AG. The remaining trademarks in this publication may be trademarks whose use by third parties for their own purposes could violate the rights of the owner.

Disclaimer of Liability

We have reviewed the contents of this publication to ensure consistency with the hardware and software described. Since variance cannot be precluded entirely, we cannot guarantee full consistency. However, the information in this publication is reviewed regularly and any necessary corrections are included in subsequent editions.

Table of contents

1	Introduction	5
1.1	History.....	5
1.2	Checking the consignment.....	5
1.3	Transportation and storage.....	6
1.4	Notes on Warranty.....	6
2	Safety notes	7
2.1	Warning Symbols.....	7
2.2	Laws and directives.....	8
2.3	Conformity with European directives.....	8
2.4	Loss of safety of device with type of protection "Intrinsic safety Ex i".....	9
3	Installing/mounting	11
3.1	Basic Safety Instructions.....	11
3.1.1	Improper Commissioning.....	11
3.1.2	Unsuitable Compressed Air.....	13
3.1.3	Prior to working on the control valve.....	13
3.1.4	Proper Mounting.....	14
3.2	Introduction.....	15
3.3	Pneumatic Connections.....	16
4	Service and maintenance	19
4.1	Maintenance.....	19
5	Dimension drawings	21
5.1	Installation and Outline Drawings.....	21
	Index	23

Tables

Table 3- 1	Weight.....	15
------------	-------------	----

Figures

Figure 3-1	SIPART PS2 Venting Gauge Block.....	15
------------	-------------------------------------	----

Introduction

These instructions contain all information required to commission and use the device. Read the instructions carefully prior to installation and commissioning. In order to use the device correctly, first review its principle of operation.

The instructions are aimed at persons mechanically installing the device, connecting it electronically, configuring the parameters and commissioning it, as well as service and maintenance engineers.

1.1 History

The contents of these instructions are regularly reviewed and corrections are included in subsequent editions. We welcome suggestions for improvement.

The following table shows the most important changes in the documentation compared to each previous edition.

Edition	Remarks
10/2014	First edition of Installation Instructions for the SIPART PS2 Venting Gauge Block.

1.2 Checking the consignment

1. Check the packaging and the delivered items for visible damage.
2. Report any claims for damages immediately to the shipping company.
3. Retain damaged parts for clarification.
4. Check the scope of delivery by comparing your order to the shipping documents for correctness and completeness.

	WARNING
<p>Using a damaged or incomplete device</p> <p>Danger of explosion in hazardous areas.</p> <ul style="list-style-type: none"> • Do not use damaged or incomplete devices. 	

1.3 Transportation and storage

To guarantee sufficient protection during transport and storage, observe the following:

- Keep the original packaging for subsequent transportation.
- Devices/replacement parts should be returned in their original packaging.
- If the original packaging is no longer available, ensure that all shipments are properly packaged to provide sufficient protection during transport. Siemens cannot assume liability for any costs associated with transportation damages.

 CAUTION
Insufficient protection during storage The packaging only provides limited protection against moisture and infiltration. <ul style="list-style-type: none">• Provide additional packaging as necessary.

1.4 Notes on Warranty

The sales contract contains the entire obligation of Siemens. The warranty contained in the contract between the parties is the sole warranty of Siemens. Any statements continued herein do not create new warranties or modify the existing warranty.

For warranty and non-warranty service, refer to Customer/Product Support in this publication.

All product designations may be trademarks or product names of Siemens Industry, Inc. or other supplier companies whose use by third parties for their own purposes could violate the rights of the owners.

Siemens Industry, Inc. assumes no liability for errors or omissions in this document or for the application and use of information in this document. The information herein is subject to change without notice.









Procedures in this document have been reviewed for compliance with applicable approval agency requirements and are considered sound practice. Neither Siemens Industry, Inc. nor these agencies are responsible for product uses not included in the approval certification(s) or for repairs or modifications made by the user.

Safety notes

This device left the factory in good working condition. In order to maintain this status and to ensure safe operation of the device, observe these instructions and all the specifications relevant to safety.

Observe the information and symbols on the device. Do not remove any information or symbols from the device. Always keep the information and symbols in a completely legible state.

2.1 Warning Symbols

Symbol	Explanation
	Consult operating instructions
	Hot surface
	Dangerous electrical voltage
	Corrosive materials
	Toxic materials
	Isolate the device from power using a circuit-breaker
	Protect the device from impact otherwise loss of degree of protection
	Protective insulation; device in protection class II

2.2 Laws and directives

Observe the test certification, provisions and laws applicable in your country during connection, assembly and operation. These include, for example:

- National Electrical Code (NEC - NFPA 70) (USA)
- Canadian Electrical Code (CEC) (Canada)

Further provisions for hazardous area applications are for example:

- IEC 60079-14 (international)
- EN 60079-14 (EC)

2.3 Conformity with European directives

The CE marking on the device shows conformity with the regulations of the following European guidelines:

Electromagnetic Compatibility EMC 2004/108/EC	Directive of the European Parliament and of the Council on the approximation of the laws of the Member States relating to electromagnetic compatibility and repealing Directive 89/336/EEC.
Atmosphère explosible ATEX 94/9/EC	Directive of the European Parliament and the Council on the approximation of the laws of the Member States concerning equipment and protective systems intended for use in potentially explosive atmospheres.
LVD 2006/95/EC	Directive of the European Parliament and of the Council of the harmonisation of the laws of Member States relating to electrical equipment designed for use within certain voltage limits.

The applied standards can be found in the EC conformity declaration of the device.

 WARNING
Improper device modifications Danger to personnel, system and environment can result from modifications to the device, particularly in hazardous areas. <ul style="list-style-type: none">• Only carry out modifications that are described in the instructions for the device. Failure to observe this requirement cancels the manufacturer's warranty and the product approvals.

Qualified personnel for hazardous area applications

Persons who install, connect, commission, operate, and service the device in a hazardous area must have the following specific qualifications:

- They are authorized, trained or instructed in operating and maintaining devices and systems according to the safety regulations for electrical circuits, high pressures, aggressive, and hazardous media.
- They are authorized, trained, or instructed in carrying out work on electrical circuits for hazardous systems.
- They are trained or instructed in maintenance and use of appropriate safety equipment according to the pertinent safety regulations.

 WARNING
Unsuitable device for the hazardous area Danger of explosion. <ul style="list-style-type: none">• Only use equipment that is approved for use in the intended hazardous area and labelled accordingly.

2.4 Loss of safety of device with type of protection "Intrinsic safety Ex i"

 WARNING
Loss of safety of device with type of protection "Intrinsic safety Ex i" If the device has already been operated in non-intrinsically safe circuits or the electrical specifications have not been observed, the safety of the device is no longer ensured for use in hazardous areas. There is a danger of explosion. <ul style="list-style-type: none">• Connect the device with type of protection "Intrinsic safety" solely to an intrinsically safe circuit.• Observe the specifications for the electrical data on the certificate and/or in Chapter "Technical data".

2.4 Loss of safety of device with type of protection "Intrinsic safety Ex i"

Installing/mounting

3.1 Basic Safety Instructions

3.1.1 Improper Commissioning

 WARNING
Improper commissioning These instructions are valid solely for the installation and commissioning of the Booster. It is absolutely necessary that you follow the safety rules, notes and requirements of the compact operating instructions before assembly, commissioning and also during operation of the positioner. You can find the compact operating instructions on the supplied CD or on the Internet under: http://www.siemens.com/processinstrumentation/documentation (http://www.siemens.com/processinstrumentation/documentation)

 WARNING
High operating force with pneumatic actuators Risk of injury when working on control valves due to the high operating force of the pneumatic actuator. <ul style="list-style-type: none">• Please observe the corresponding safety instructions for the pneumatic actuator in use.

 WARNING
Lever for position detection Danger of crushing and shearing with mounting kits which use a lever for position detection. During commissioning and ongoing operation, severing or squeezing of limbs could occur as a result of the lever. Risk of injury when working on control valves due to the high operating force of the pneumatic actuator. <ul style="list-style-type: none">• Do not reach into the range of motion of the lever following mounting of the positioner and mounting kit.

 WARNING
Impermissible accessories and spare parts Danger of explosion in areas subject to explosion hazard. <ul style="list-style-type: none">• Only use original accessories or original spare parts.• Observe all relevant installation and safety instructions described in the instructions for the device or enclosed with the accessory or spare part.

 WARNING
It is possible to damage the cover gasket If the cover gasket is not positioned correctly in the groove of the base plate, it could be damaged when the cover is mounted and screwed tight. <ul style="list-style-type: none">• Therefore make sure that the gasket is seated correctly.

 WARNING
Open cable inlet or incorrect cable gland Danger of explosion in hazardous areas. <ul style="list-style-type: none">• Close the cable inlets for the electrical connections. Only use cable glands or plugs which are approved for the relevant type of protection.

 WARNING
Exceeded maximum ambient or process media temperature Danger of explosion in hazardous areas. Device damage.

3.1.2 Unsuitable Compressed Air

NOTICE
Caution Use of process fluids other than instrument air is not recommended. No claim is made as to the suitability of this product for use with other process fluids.

3.1.3 Prior to working on the control valve





3.1.4 Proper Mounting

NOTICE
Incorrect mounting The device can be damaged, destroyed, or its functionality impaired through improper mounting. <ul style="list-style-type: none">• Before installing ensure there is no visible damage to the device.• Make sure that process connectors are clean, and suitable gaskets and glands are used.

 CAUTION
Loss of degree of protection Damage to device if the enclosure is open or not properly closed. The degree of protection specified on the nameplate is no longer guaranteed. <ul style="list-style-type: none">• Make sure that the device is securely closed.

3.2 Introduction

In that condition where you are using a Double Acting SIPART PS2 with a Single Acting actuator, the following must be considered:

With loss of supply air the Double Acting SIPART PS2 will lock in the last position. This prevents the actuator spring from returning the valve to its fail-safe position. By using the "venting" gauge block and properly piping the positioner to the actuator the air on the side opposite the spring can be exhausted back through the air supply line.

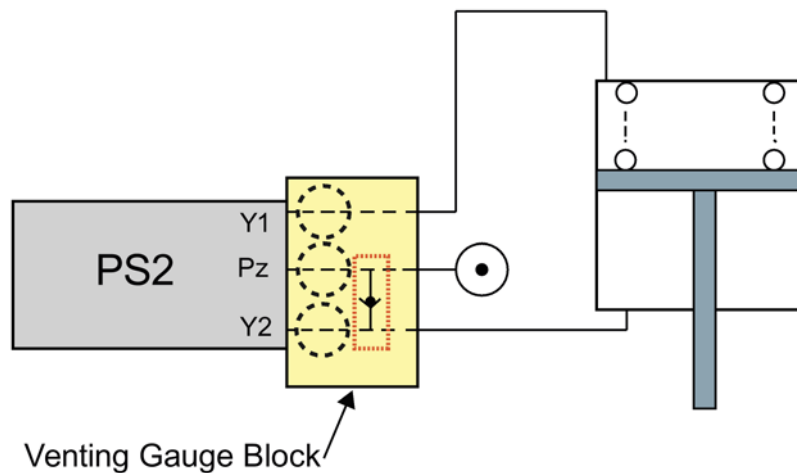

Figure 3-1 SIPART PS2 Venting Gauge Block

Specifications

Supply Pressure = 7 BAR (101.5 PSI)

Table 3- 1 Weight

	Makrolon		Explosion Proof	
	With PS2	Kit only	With PS2	Kit only
Venting Gauge Block	1.7 kg (3.8 lbs)	680.39 g (1.5 lbs)	5.3 kg (11.6 lbs)	680.39 g (1.5 lbs)

Ordering Information

The booster can be ordered as a kit to add to an existing positioner in the field, or can be ordered as an option on a new unit.

Kit Numbers

6DR4004-2RF Venting Gauge Block, Double Acting, 1/4" NPT connections

6DR4004-2RE Venting Gauge Block, Double Acting, G 1/4 connections

Model Option Codes

R2F Venting Gauge Block, Double Acting, 1/4" NPT connections

R2E Venting Gauge Block, Double Acting, G 1/4 connections

3.3 Pneumatic Connections

Refer to Installation drawings for the locations of the pneumatic connections. The supply and output connections are 1/4" NPT. Ideally the SIPART PS2 Venting Gauge Block assembly should be close coupled to the actuator. Tubing of 1/4" O.D. or larger is recommended for piping.

Blow out all piping before connections are made to prevent the possibility of dirt or chips entering the relay. Use pipe sealant sparingly, and then only on the male threads. A non-hardening sealant is strongly recommended. Connect the relay to a source of clean, dry, oil-free instrument air. See Instrument Air Requirements.

NOTICE
Caution Pressure in excess of 7 BAR (101.5 PSI) to any connection may cause damage to the relay. In any event, maximum actuator pressure should never be exceeded.

Instrument Air Requirements

NOTICE
Caution Use of process fluids other than instrument air is not recommended. No claim is made as to the suitability of this product for use with other process fluids.

NOTICE
Caution Synthetic compressor lubricants in the air system at the instrument may cause the instrument to fail.

There are many types of synthetic compressor lubricants. Some may not be compatible with materials used in construction of the relay. Wetting of these materials with such an oil mist or oil vapor, etc., may cause deterioration and may ultimately result in the failure of the instrument. Refer to Specifications for a list of materials.

The requirements for a quality air supply can be found in the Instrument Society of America's "Quality Standard for Instrument Air" (ISA-S7.3). Basically this standard calls for the following:

Particle Size – The particle size in the air stream at the instrument shall be no larger than 3 microns.

Dew Point – The dew point, at line pressure, should be at least 10°C (18°F) below the minimum temperature to which any part of the instrument air system is exposed at any

season of the year. Under no circumstances should the dew point, at line pressure, exceed 2°C (35.6°F).

Oil Content – The maximum total oil or hydrocarbon content, exclusive of non-condensable, should not exceed 1 ppm under normal operating conditions.

Service and maintenance

4.1 Maintenance

These instruments do not normally require any routine maintenance.

NOTICE
Caution Before disassembling the unit, make sure all air pressure to the unit is turned off.

Customer/Product Support

This section provides the Internet site addresses, e-mail addresses, telephone numbers, and related information for customers to access Siemens product support.

When contacting Siemens for support:

- Please have complete product information at hand:
 - For hardware, this information is provided on the product nameplate (part number or model number, serial number, and/or version).
 - For most software, this information is given in the Help > About screen.
- If there is a problem with product operation:
 - Is the problem intermittent or repeatable? What symptoms have been observed?
 - What steps, configuration changes, loop modifications, etc. were performed before the problem occurred?
 - What status messages, error messages, or LED indications are displayed?
 - What troubleshooting steps have been performed?
 - Is the installation environment (e.g. temperature, humidity) within the product's specified operating parameters? For software, does the PC meet or exceed the minimum requirements (e.g. processor, memory, operating system)?
- A copy of the product Service Instruction, User's Manual, or other technical literature should be at hand. The Siemens public Internet site (see the table) has current revisions of technical literature, in Portable Document Format, for downloading.
- To send an instrument to Siemens for repair, request a Return Material Authorization (RMA).

NOTICE
Important An instrument must be thoroughly cleaned (decontaminated) to remove any process materials, hazardous materials, or blood born pathogens prior to return for repair. Read and complete the Siemens RMA form(s).

Support is available through an online Support Request service; a link is provided in the table below.

4.1 Maintenance

For support and the location of your local Siemens representative, refer to the table below for the URL of the Process Instrumentation (PI) portion of the Siemens public Internet site. Once at the site, click Support in the right column and then Product Support. Next select the type of support desired: sales, technical (see the table below), documentation, or software.

Online Support Request	http://www.siemens.com/automation/support-request (http://www.siemens.com/automation/support-request)
Technical Support	1-800-333-7421; 8 a.m. to 4:45 p.m. eastern time, Monday through Friday (except holidays)
Customer Service & Returns	1-800-365-8766 (warranty and non-warranty)
Public Internet Site	http://www.usa.siemens.com/pi (http://www.usa.siemens.com/pi)
Technical Publications in PDF	Click the above link to go to the Siemens Internet site and then click Process Instrumentation. In the column to the right, click Support > Manuals. In the column to the left, select the product line (e.g. Pressure or Temperature or Controllers) to open navigation and search panes. Note: Navigation may change as the site evolves.

Dimension drawings

5.1 Installation and Outline Drawings

The following installation and outline drawings are used with this device:

A5E34493121A Rev AB - Installation Drawing, Venting Gauge Block, PS2, FP (16152-1431)

A5E34493121B Rev AB - Installation Drawing, Venting Gauge Block, PS2 (16152-1432)

此圖紙之內容
 未經本公司
 之正式批准
 不得翻印或
 複製

This document as
 well as its content
 is not to be
 reproduced or
 transmitted in
 any form or by
 any means
 without the
 express written
 permission of
 Siemens AG

Reproduction or
 transmission in
 any form or by
 any means
 without the
 express written
 permission of
 Siemens AG

This document as
 well as its content
 is not to be
 reproduced or
 transmitted in
 any form or by
 any means
 without the
 express written
 permission of
 Siemens AG

This document as
 well as its content
 is not to be
 reproduced or
 transmitted in
 any form or by
 any means
 without the
 express written
 permission of
 Siemens AG

This document as
 well as its content
 is not to be
 reproduced or
 transmitted in
 any form or by
 any means
 without the
 express written
 permission of
 Siemens AG

This document as
 well as its content
 is not to be
 reproduced or
 transmitted in
 any form or by
 any means
 without the
 express written
 permission of
 Siemens AG

This document as
 well as its content
 is not to be
 reproduced or
 transmitted in
 any form or by
 any means
 without the
 express written
 permission of
 Siemens AG

This document as
 well as its content
 is not to be
 reproduced or
 transmitted in
 any form or by
 any means
 without the
 express written
 permission of
 Siemens AG

A 1 2 3 4 5 6 7 8
 B
 C
 D
 E
 F

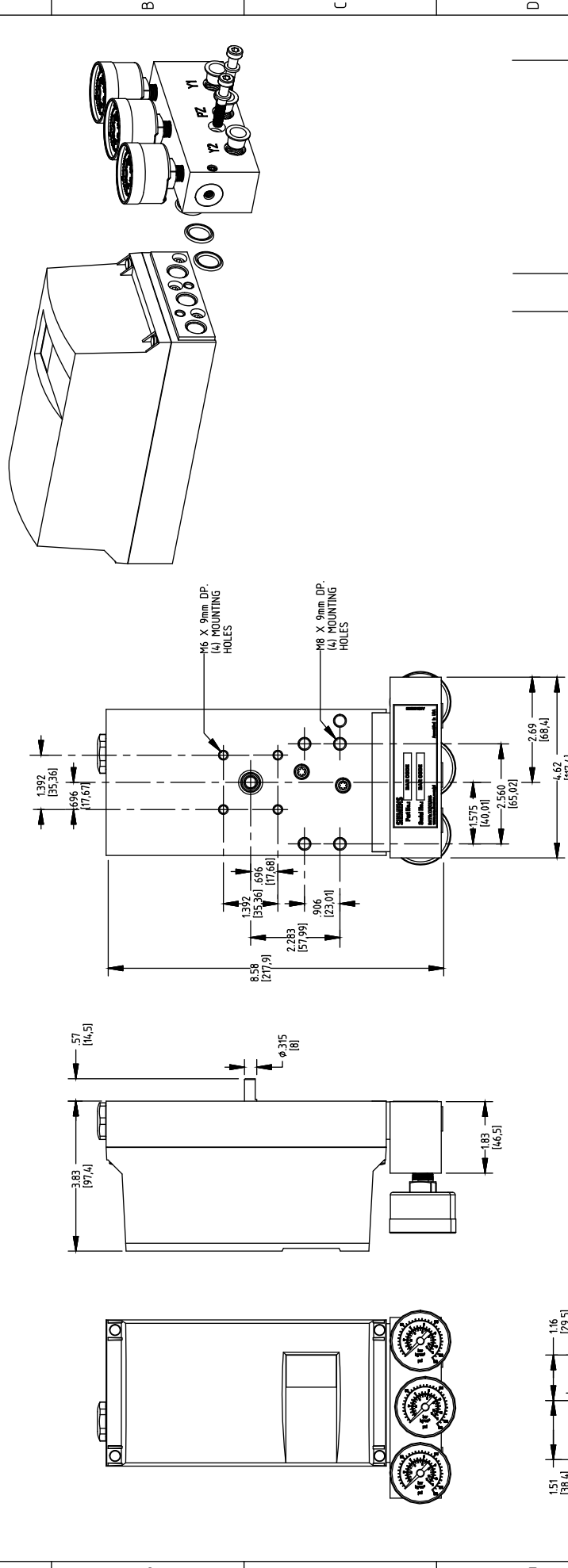

SCALE: 0.4-1

Tolerance: .XX ±0.2
 .XXX ±0.05

REV.	DESCRIPTION	APPD.
002	10/6/14, CO. PSA00093009 ADDED "G" THD. REFERENCE	VDB
001	6/18/14, CO. PSA00077074	VDB

Material: SEE NOTES
 Weight: 0.000 lb.
 Scale: 1:1
 Unit: inch

Surface: VDB
 Author: FALSE
 Creator: s. PDM
 Approval: s. PDM
 Department: s. PDM
 Change Order: s. PDM
 Doc. State: 002
 Revision: AB
 Index: RS
 Project No: 16152-1432

INSTL DWG, VGB, PSZ

SIEMENS
 © Siemens AG

Doc. No.	Item No.	Doc. Type
A5E34493121B	A5E34493121	B
16152-1432	16152-1432	1 of 1

Index

C

Certificates, 8
Correct usage, (See improper device modifications)
Customer Support, 19

D

Drawings
 Installation and Outline, 21

H

Hazardous area
 Laws and directives, 8
History, 5

I

Improper device modifications, 8
Installation, 15
Instrument Air Requirements, 16

K

Kit Numbers, 15

M

Maintenance, 19
Model Option Codes, 16

O

Ordering Information, 15

P

Pneumatic Connections, 16

Q

Qualified personnel, 9

S

Scope of delivery, 5
SIPART PS2 Venting Gauge Block, 15
Specifications
 Weight, 15
Symbols, (Refer to warning symbols)

T

Test certificates, 8

W

Warning symbols, 7
Warranty, 6

For more information

www.siemens.delsipartps2

Siemens Industry, Inc.
Industry Automation Division
Valve Positioner
Spring House, PA 19477
USA

Subject to change without prior notice
Order No.: A5E34388399
Lit. No.: A5E34388399-AD
12.2014
All rights reserved
Printed in USA
© 2014 Siemens Industry, Inc.

www.siemens.com/processautomation