

USER GUIDE: 17 651 1000 01/20 Rev -

Preventative Maintenance Guide: 17 651 1100

NITROGEN GAS GENERATOR

NITROSource Compact

N2C-2 / N2C-4 / N2C-6 / N2C-8



N₂

User Guide

(EN)



CONTENTS

- | | | | |
|----|---|----|---|
| 05 | - Safety Information | 16 | - Mechanical Installation |
| 06 | - Markings and Symbols
- Approvals | 17 | - Electrical Installation |
| 08 | - Receiving and Inspecting the Equipment
- Storage | 18 | - Generator Supply
- Dryer Supply
- Purge Economy
- Remote Switching |
| 09 | - Unpacking | 19 | - Alarm Contacts
- 4-20mA Analogue Output |
| 11 | - Overview of the Equipment | 21 | - Overview of the Controls |
| 13 | - Environment
- Space Requirements
- Ventilation Requirements
- Air Inlet Quality
- Electrical Requirements | 22 | - Starting the Generator
- Stopping the Generator |
| 15 | - Recommended System Layout
- Buffer Vessel Selection | 23 | - Menu Interface
- Hour Meters |
| | | 24 | - Fault Log
- Customer Settings |

CONTENTS

- 26
 - Changing Parameters
 - Oxygen Content
 - Economy Mode
- 28
 - Cleaning
 - Service Intervals
- 29
 - Service Kits
- 30
 - Exhaust Silencer Replacement
 - Oxygen Cell Replacement
- 31
 - Oxygen Analyser Calibration
 - Using a Calibrated Gas Supply
 - Using a Calibrated Independent Analyser
 - Using Compressed Air
- 32
 - Entering the Calibrated Level
- 33
 - Filter Depressurisation
 - Filter Bowl Removal
- 34
 - Insertion of Replacement Element
 - Replacement of Filter Head O-Ring
 - Reconnecting the Filter Bowl with Head
- 36
 - Description
- 37
 - Technical Specification
- 38
 - Inlet Parameters
 - Environmental Parameters
 - Port Connections
 - Electrical Parameters
 - Packed Weights and Dimensions
- 39
 - Generator Weights and Dimensions
- 40
 - Troubleshooting
- 41
 - Declaration of Conformity
- 42
 - Schematics

SAFETY

SAFETY INFORMATION

Do not operate this equipment until the safety information and instructions in this user guide have been read and understood by all personnel concerned.

USER RESPONSIBILITY

FAILURE OR IMPROPER SELECTION OR IMPROPER USE OF THE PRODUCTS DESCRIBED HEREIN OR RELATED ITEMS CAN CAUSE DEATH, PERSONAL INJURY AND PROPERTY DAMAGE.

This document and other information from Parker-Hannifin Corporation, its subsidiaries and authorised distributors provide product or system options for further investigation by users having technical expertise.

The user, through its own analysis and testing, is solely responsible for making the final selection of the system and components and assuring that all performance, endurance, maintenance, safety and warning requirements of the application are met. The user must analyse all aspects of the application, follow applicable industry standards, and follow the information concerning the product in the current product catalogue and in any other materials provided from Parker or its subsidiaries or authorised distributors.

To the extent that Parker or its subsidiaries or authorised distributors provide component or system options based upon data or specifications provided by the user, the user is responsible for determining that such data and specifications are suitable and sufficient for all applications and reasonably foreseeable uses of the components or systems.

The pressure envelope of the generator must not be breached under any circumstances. Failure to comply may result in an unplanned release of pressure, and may cause serious personal injury or death. All maintenance procedures that require the pressure envelope to be breached must only be performed by competent personnel trained, qualified, and approved by Parker.

Due to the nature of operation there is a possibility of oxygen enrichment surrounding the generator. Ensure that the area is adequately ventilated. Where the risk of oxygen enrichment is high, such as a confined space or poorly ventilated room, the use of oxygen monitoring equipment is advisable.

Nitrogen is not a poisonous gas but, in a concentrated form, there is a risk of asphyxiation. Depending upon the model and operating pressure, the generator is capable of delivering nitrogen at a flow rate of 47.64 m³/hr. If the generator is operated within a confined space ensure that adequate ventilation and oxygen monitoring equipment is fitted.

Use of the equipment in a manner not specified within this user guide may result in an unplanned release of pressure, which may cause serious personal injury or damage.

When handling, installing or operating this equipment, personnel must employ safe engineering practices and observe all related regulations, health & safety procedures, and legal requirements for safety.

Ensure that the equipment is depressurised and electrically isolated, prior to carrying out any of the scheduled maintenance instructions specified within this user guide.

Only competent personnel trained, qualified, and approved by Parker should perform installation, commissioning, service and repair procedures.

Note: Any interference with the calibration warning labels will invalidate the gas generator's warranty and may incur costs for the re-calibration of the gas generator.

Parker can not anticipate every possible circumstance which may represent a potential hazard. The warnings in this manual cover the most known potential hazards, but by definition can not be all-inclusive. If the user employs an operating procedure, item of equipment or a method of working which is not specifically recommended by Parker the user must ensure that the equipment will not be damaged or become hazardous to persons or property.

Most accidents that occur during the operation and maintenance of machinery are the result of failure to observe basic safety rules and procedures. Accidents can be avoided by recognising that any machinery is potentially hazardous.

Details of your nearest Parker sales office can be found at www.parker.com/gsfe

Retain this user guide for future reference.

MARKINGS AND SYMBOLS

The following markings and international symbols are used on the equipment or within this user guide:

	Caution, Read the User Guide.		Wear ear protection.
	Risk of electric shock.		Pressurised components on the system.
 Warning	Highlights actions or procedures which, if not performed correctly, may lead to personal injury or death.		Remote control. Generator may start automatically without warning.
 Caution	Highlights actions or procedures which, if not performed correctly, may lead to damage to this product.		Conformité Européenne
 Warning	Highlights actions or procedures which, if not performed correctly, could lead to electric shock.		Dispose in accordance with local regulations
	Read the User Guide.		Safety gloves to be worn
 NITROGEN (N ₂) DO NOT BREATHE Asphyxiant in high concentrations. No odour. Slightly lighter than air. Ensure adequate ventilation. Breathing 100% nitrogen will produce immediate unconsciousness and death due to lack of oxygen. NON-FLAMMABLE COMPRESSED GAS			Use a forklift truck to move the generator

APPROVALS

SAFETY AND ELECTROMAGNETIC COMPATIBILITY	
	This equipment has been tested and complies with the following European Standards:
	EN 61010-1: 2010 Safety Requirements for Electrical Equipment for Measurement, Control, and Laboratory use - Part 1: General Requirements
	EN 61000-6-2: 2005 Electromagnetic compatibility (EMC) - Part 6-2: Generic standards - Immunity for industrial environments
EN 61000-6-4: 2007, A1:2011	Electromagnetic compatibility (EMC) - Specifies the electromagnetic compatibility emission requirements for electrical and electronic equipment and components designed for industrial environments. It covers the frequency range 0 Hz to 400 GHz. This standard concerns electrical equipment that has to be connected to a power network, or uses battery power in an industrial environment - whether it's indoors or outdoors. For a location to be classified as industrial, it has to have industrial, scientific and medical apparatus; heavy inductive or capacitive loads; and high currents associated with electromagnetic fields

RECEIVING AND INSPECTING THE EQUIPMENT

RECEIVING AND INSPECTING THE EQUIPMENT

The equipment is supplied in a sturdy wooden crate designed to be moved using a forklift truck or pallet truck. Refer to the technical specification for packed weights and dimensions.

On delivery of the equipment check the crate and its contents for damage and verify that the following items have been included:

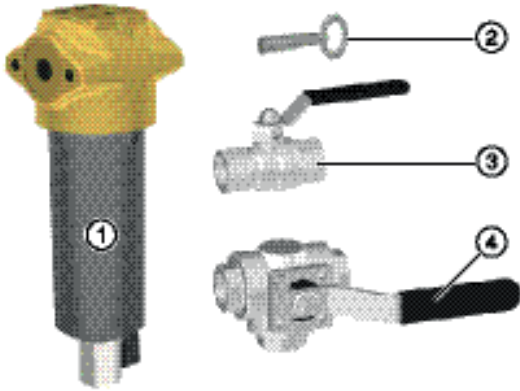

REF	DESCRIPTION	QTY
1	AOP010	1
2	Access Key	1
3	½" Ball Valve	3
4	½" 3-Way Ball Valve	1

If there are any signs of damage to the crate, or there are any parts missing please inform the delivery company immediately and contact your local Parker office.

STORAGE

The equipment should be stored, within the packing crate, in a clean dry environment. If the crate is stored in an area where the environmental conditions fall outside of those specified in the technical specification, it should be moved to its final location (installation site) and left to stabilise prior to unpacking. Failure to do this could cause condensing humidity and potential failure of the equipment.

UNPACKING

Remove the lid and all four sides of the packing crate (01) and unscrew the 4x transit bolts securing the generator to the base of the crate(02). Lift the generator from the pallet using suitable slings and an overhead crane (03). Carefully move the generator to its final location, using a forklift truck or pallet truck, and refit the silencer (04).

01

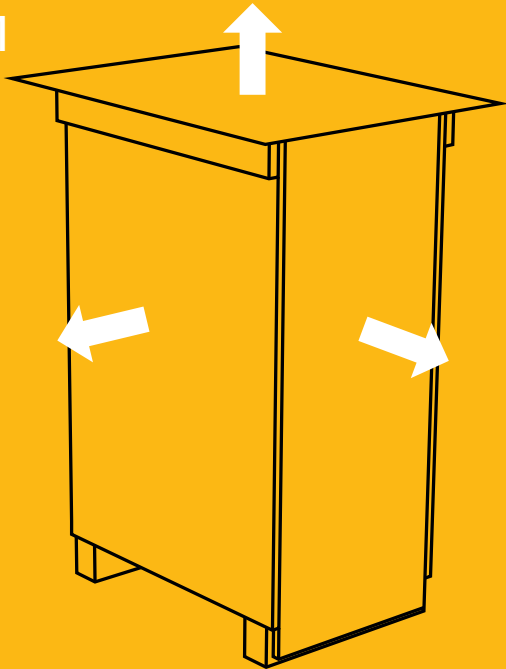

02

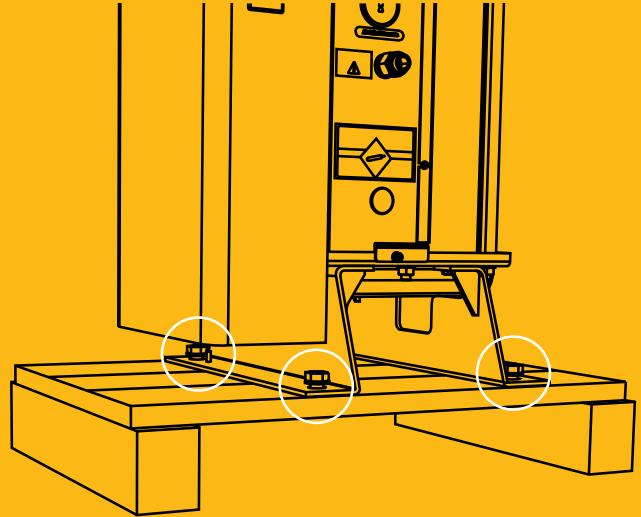

03

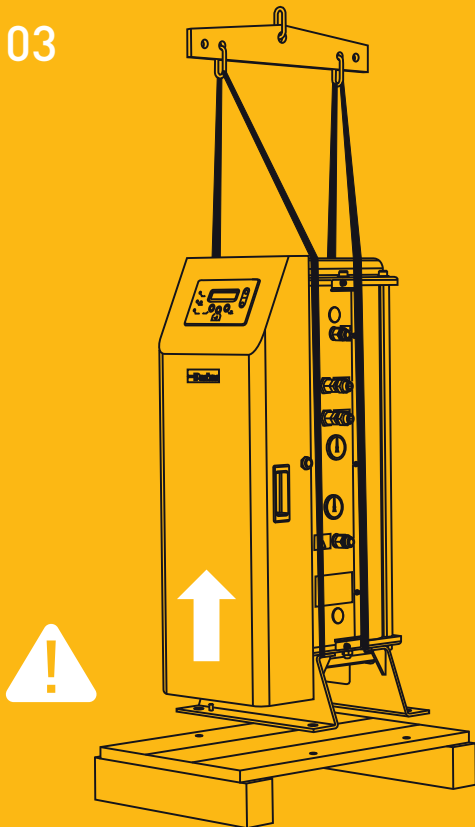

04

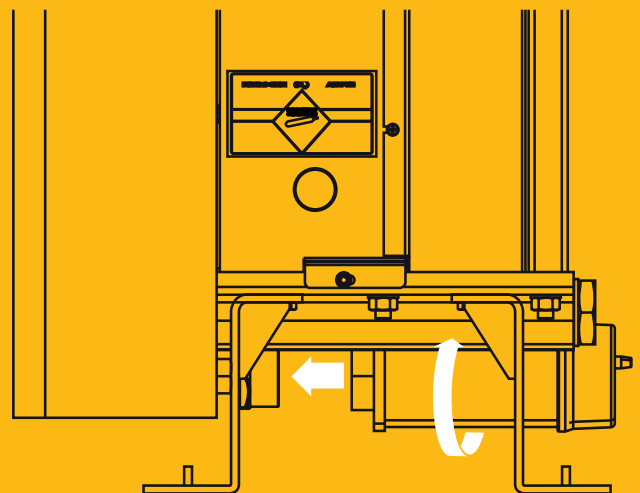

OVERVIEW OF THE EQUIPMENT

OVERVIEW OF THE EQUIPMENT

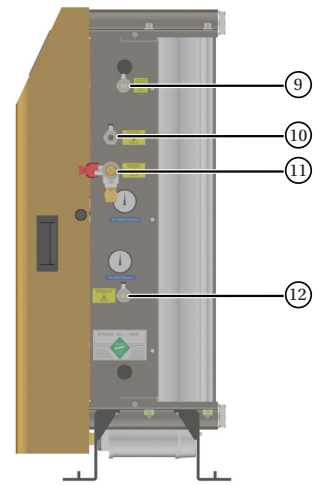
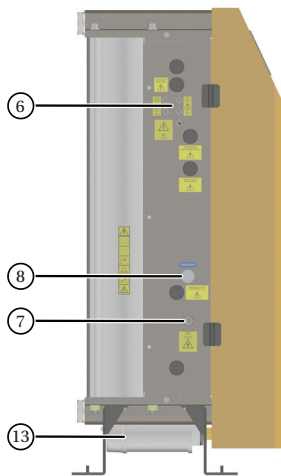
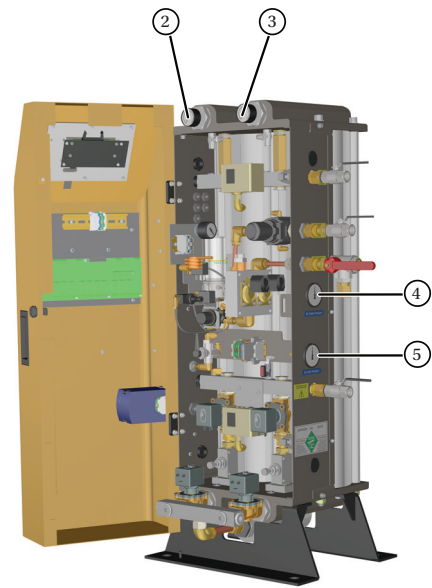
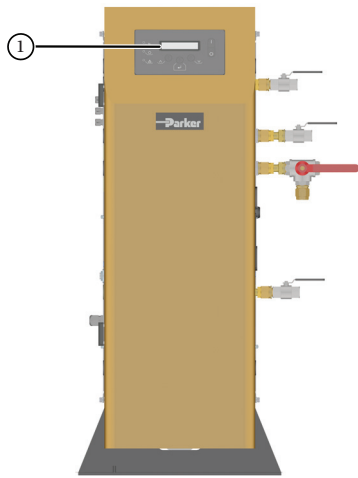

REF	DESCRIPTION	REF	DESCRIPTION
1	User control interface	8	O ₂ Analyser calibration port
2	Column A pressure gauge	9	N ₂ Outlet port to buffer (G ¹ / ₂)
3	Column B pressure gauge	10	N ₂ inlet port from buffer vessel (G ¹ / ₂)
4	N ₂ Outlet pressure gauge	11	N ₂ Outlet port (G ¹ / ₂)
5	Air inlet pressure gauge	12	Air Inlet port (G ¹ / ₂)
6	Cable glands	13	Silencer
7	Mains supply cable gland		

LOCATING THE EQUIPMENT

ENVIRONMENT

The equipment should be located indoors in an environment that protects it from direct sunlight, moisture, and dust. Changes in temperature, humidity, and airborne pollution will affect the environment in which the equipment is operating and may impair the safety and operation. It is the customers' responsibility to ensure that the environmental conditions specified for the equipment are maintained.

SPACE REQUIREMENTS

The equipment should be mounted on a flat surface capable of supporting its own weight plus the weight of all ancillary parts. There must be adequate space around the equipment to allow airflow and access for maintenance purposes and lifting equipment. A minimum spacing of approximately 500mm (20") is recommended around all sides.

Do Not position the equipment so that it is difficult to operate or disconnect from the electrical supply.

Once positioned the equipment should be secured to the floor using M20 bolts.

VENTILATION REQUIREMENTS



Warning

Due to the nature of operation there is a possibility of oxygen enrichment surrounding the generator. Ensure that the area is adequately ventilated. Where the risk of oxygen enrichment is high, such as a confined space or poorly ventilated room, the use of oxygen monitoring equipment is advisable.

Nitrogen is not a poisonous gas but, in a concentrated form, there is a risk of asphyxiation. Depending upon the model and operating pressure, the generator is capable of delivering nitrogen at a flow rate of 47.64 m³/hr. If the generator is operated within a confined space ensure that adequate ventilation and oxygen monitoring equipment is fitted.

AIR INLET QUALITY

This generator is designed for use with clean dry compressed air in accordance with ISO 8573-1:2010 class 2.2.1.

ISO8573-1:2010 is an international standard that specifies the purity classes of compressed air with respect to solid particulates, water and oil. Understanding the requirements of the standard falls outside of the scope of this manual, however the following table summarises the classification for each contaminant. Further information on ISO 8573-1 can be found in the domnick hunter publication "A GUIDE TO THE ISO8573 SERIES COMPRESSED AIR QUALITY STANDARD" (Stock Number: 17 400 4765).

ISO 8573-1:2010 class 2.2.1 equates to the following:

Class 2 (Solid Particulate)

In each cubic metre of compressed air, the particulate count should not exceed 400,000 particles in the 0.1 - 0.5 micron size range, 6,000 particles in the 0.5 - 1 micron size range and 100 particles in the 1 - 5 micron size range.

Class 2 (Water)

A pressure dewpoint (PDP) of -40°C or better is required and no liquid water is allowed.

Class 1 (Oil)

In each cubic metre of compressed air, not more than 0.01mg of oil is allowed. This is a total level for liquid oil, oil aerosol and oil vapour.

ELECTRICAL REQUIREMENTS

Connection to the electrical supply should be made through a switch or circuit breaker rated at 250VAC, 15A with a minimum short circuit rating of 10KA. This device should have a disconnection time not exceeding 40mS and all current carrying conductors should be disconnected.

The device chosen should be clearly and indelibly marked as the disconnecting device for the equipment and be located in close proximity to the equipment and within easy reach for the operator.

Over current protection must be fitted as part of the building installation. This protection should be selected in accordance with local and national code regulations with a minimum short circuit rating of 10KA.

INSTALLATION AND COMMISSIONING



Only competent personnel trained, qualified, and approved by Parker should perform installation, commissioning, service and repair procedures.

Warning

RECOMMENDED SYSTEM LAYOUT

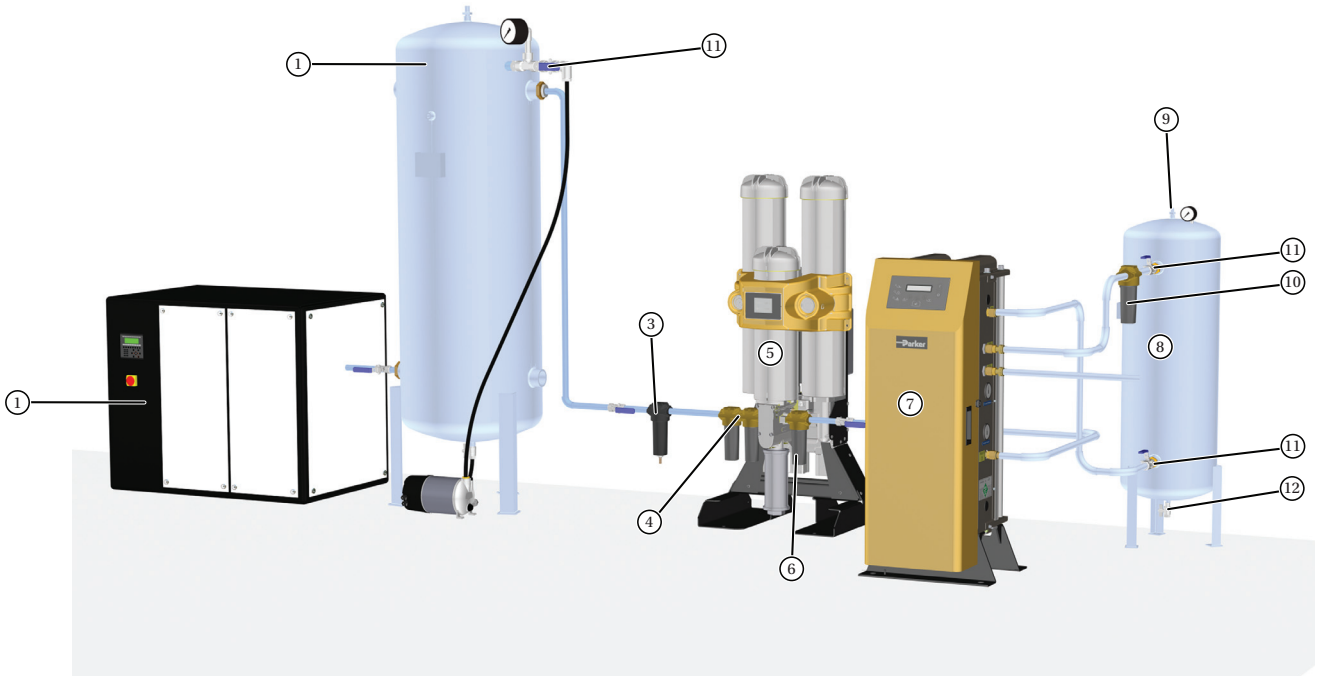

REF	DESCRIPTION	REF	DESCRIPTION	REF	DESCRIPTION	REF	DESCRIPTION
1	Compressor	4	Dryer pre-filtration	7	N ₂ Compact generator	10	AO Filter (supplied)
2	Wet air receiver	5	Pre-treatment dryer	8	Buffer vessel	11	Ball valve
3	Water Separator	6	AO Filter	9	Pressure relief valve	12	Drain valve

BUFFER VESSEL SELECTION

The buffer selection should be sized according to the flowrate of the generator.

FLOWRATE		VESSEL CAPACITY
M ³ /HR	CFM	L
0 - 3	0 - 1.8	50
3.1 - 7.5	1.9 - 4.4	150
7.6 - 12.3	4.5 - 7.2	250
12.4 - 24	7.3 - 14.1	500
24.1 - 34	14.2 - 20	750

MECHANICAL INSTALLATION

- A. Fit one of the ½" ball valves supplied to the compressed air inlet port on the generator and attach the compressed air supply to this ball valve. Ensure that the valve is in the closed position.
- B. Fit another of the ½" ball valves supplied to the port marked "To Buffer vessel". Install ½" NB / 16mm ID piping between the ball valve and the buffer vessel inlet port. It is recommended that a ball valve (not supplied) be installed at the inlet to the buffer vessel to allow it to be isolated during maintenance.
- C. Fit the remaining ½" ball valve to the port marked "From Buffer vessel". Install ½" NB / 16mm ID piping between the ball valve and the outlet port of the buffer vessel. The AOP010 filter provided should be installed in this line. Follow the installation instructions provided with the filter taking note of the direction of flow. It is recommended that a ball valve (not supplied) be installed at the outlet of the buffer vessel to allow it to be isolated during maintenance.
- D. Fit the 3-way ball valve supplied to the port marked "Nitrogen Outlet". Connect this ball valve to the application using ½" NB / 16mm ID piping. This piping must be solid and non-porous to minimise the ingress of oxygen.

Note. The nitrogen buffer vessel must be rated to at least the maximum operating pressure of the generator and must be fitted with a suitable pressure gauge and pressure relief valve.

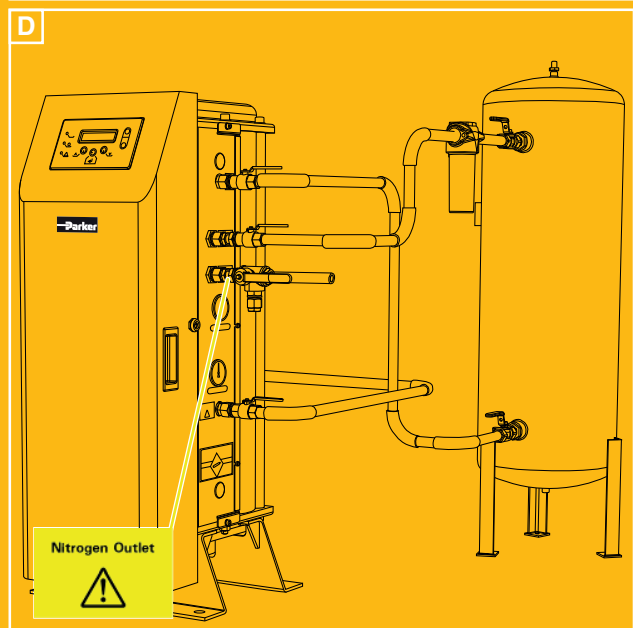
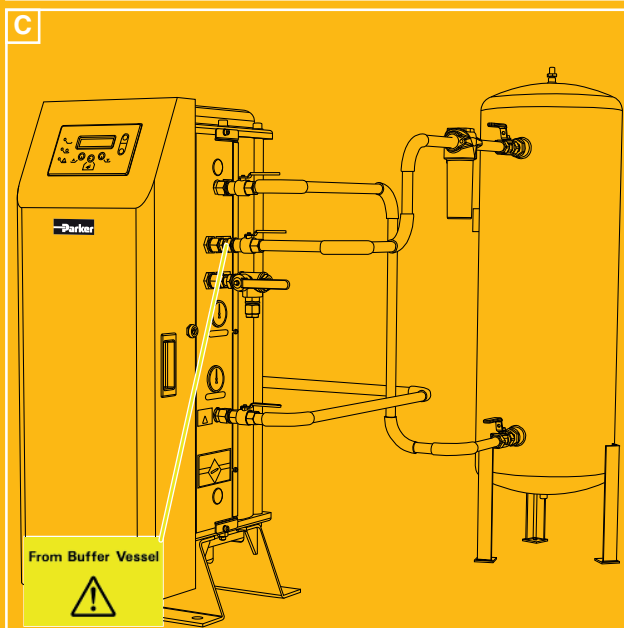
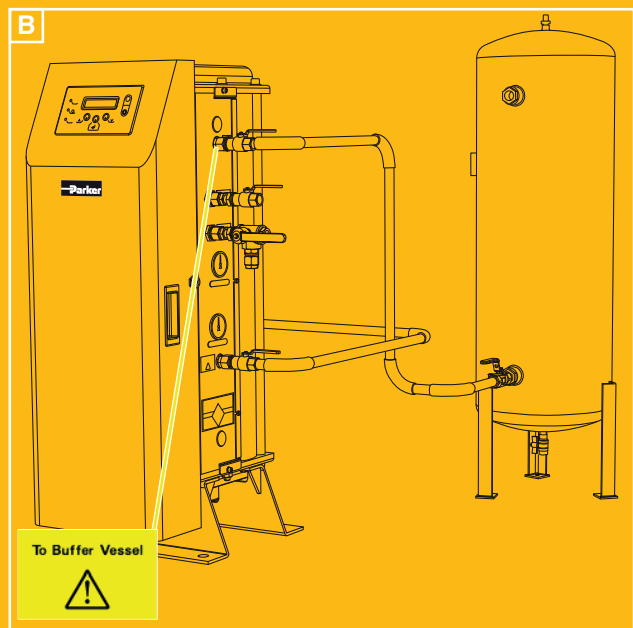
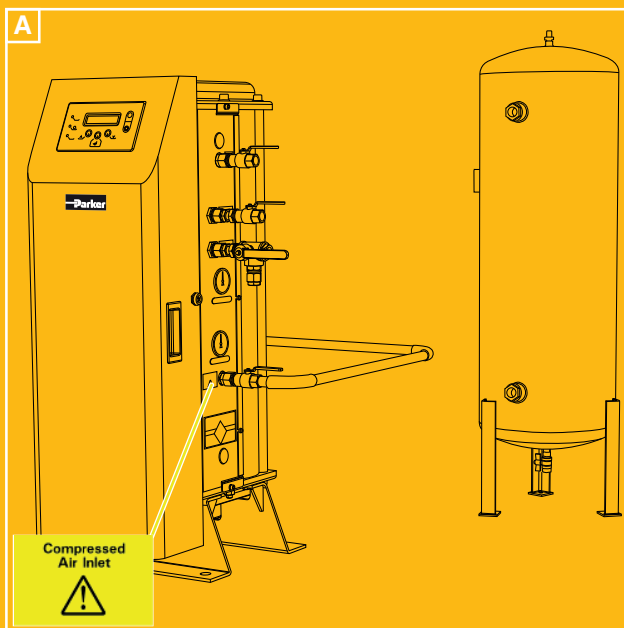

ELECTRICAL INSTALLATION



Warning

A fully qualified electrical engineer must undertake all field wiring and electrical work in accordance with local regulations.

In order to maintain the IP rating of the generator, all cables entering the electrical enclosure must do so through the dedicated cable glands located on the side of the generator.

Refer to the wiring schematics at the rear of the manual for details of the required terminations. All terminals are identified in the image below.

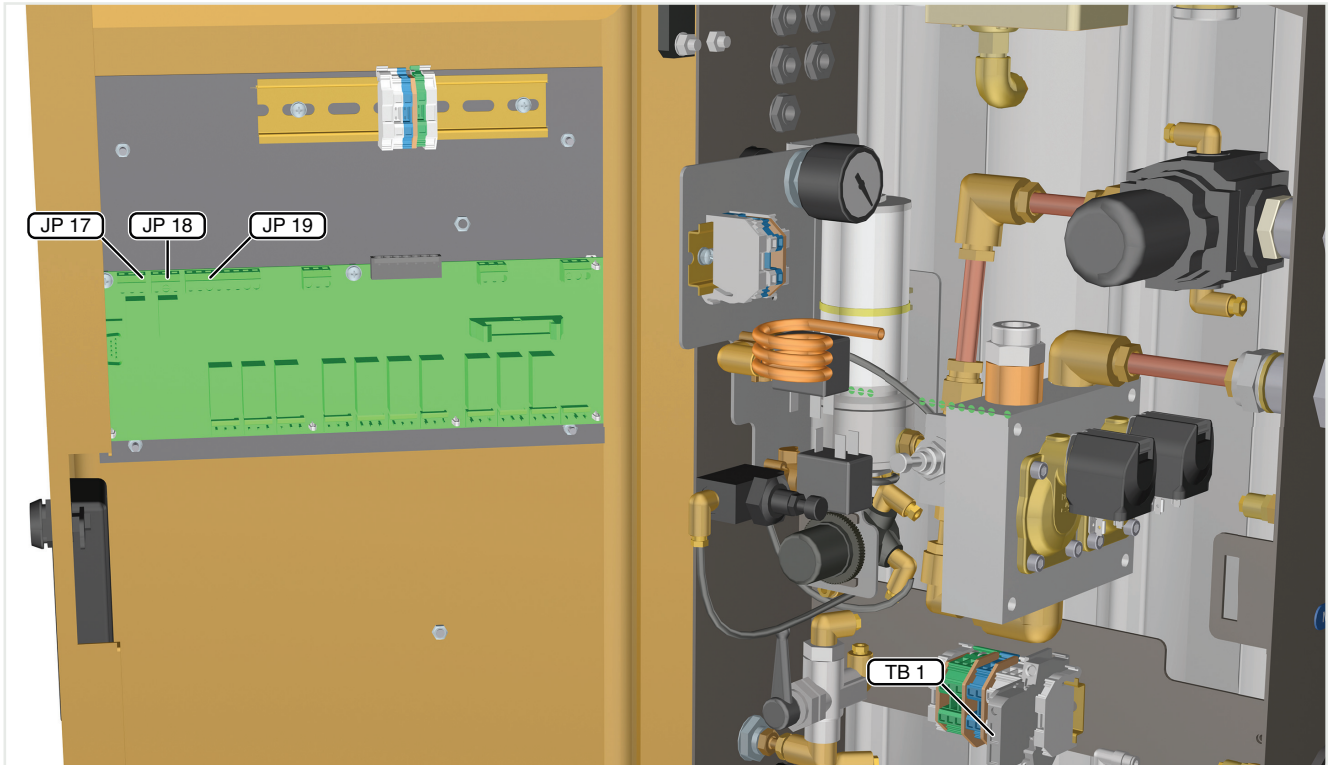

REF	CONNECTION	TERMINAL	NOTES	CABLE DIAMETER
TB1	Generator Supply	 FUSE 3.15 A · 1'250V 5x20mm	L - Fuse terminal for the phase conductor N - Neutral conductor ⚡ - Protective Earth conductor	6 - 12 mm
TB1	Dryer Supply	L (Grey) N (Blue) (Yellow / Green)	Dryer Live conductor Dryer Neutral conductor Dryer Earth conductor	3 - 7 mm
JP 17	Purge Economy	JP 17-1 (NC) JP 17-2 (COM) JP 17-3 (NO)	Not Used The relay is energised when the generator is in standby Refer to installation instructions for the dryer	3 - 7 mm
JP 18	Alarm Contacts	JP 18-1 (NC) JP 18-2 (COM) JP 18-3 (NO)	The relay is energised when no faults are present	3 - 7 mm
JP 19	Remote Switching	JP 19-7 JP 19-8	(INPUT 4) Remote switching is activated in the customer settings menu	3 - 7 mm
	MODBUS	A B	RS485 MODBUS For MODBUS communication setup details refer to publication - 17 650 0012	



Warning

When wiring to the terminals of JP17, JP18 and JP19 ensure that the wires are secured so that, in the event of one coming loose, they cannot short out against the surrounding terminals.

GENERATOR SUPPLY



Warning

For safety reasons the generator must be connected to earth at the earth terminal provided on TBI.

The generator supply terminals are designed to accommodate a maximum conductor size of 2.5mm² (14 AWG). It is the users responsibility to size the supply cable in accordance with local wiring regulations, taking in to account cable temperatures, installation methods and voltage drop.

The protective earth conductor should be longer than the associated phase conductors so that in the event of the cable slipping in the cable gland, the earth will be the last to take the strain.

DRYER SUPPLY

If a Parker pre-treatment air dryer is used, it should be connected to the generator at the dedicated DIN rail terminals. Refer to the documentation provided with your dryer for additional information on installation requirements.

PURGE ECONOMY

If the pre-treatment dryer is fitted with a purge economy feature, it may be controlled using the volt free relay contacts on JP17. The relay is energised only when the generator enters standby mode.

Refer to the documentation provided with your dryer for details on purge economy.

REMOTE SWITCHING

The generator may be controlled remotely by connecting a remote start / stop circuit to JP19-7 and JP19-8 on the control board. When the circuit is open the generator should remain in standby mode, closing the circuit should initiate a start command.

To enable the remote switching function refer to “Customer Settings ” on page 25 of this guide. Once the remote switching function has been enabled the local start control will no longer function.



Warning

When the remote switching function is enabled the generator can start without warning.

ALARM CONTACTS

The generator is fitted with a set of volt free relay contacts designed for connection to a remote alarm circuit. The contacts are rated 1A max @ 250 Vac (1A @ 30Vdc). Under normal operation the relay is energised, when a fault occurs the relay will de-energise causing the relay contacts to change state.



Warning

If the generator is connected to a remote alarm circuit, the electrical enclosure will contain more than one live circuit. In the event of the generator electrical power supply being disconnected, the fault relay connections will remain live. It is the users responsibility to provide a disconnection device so that these connections can be safely isolated.

4-20mA ANALOGUE OUTPUT

The oxygen content detected by the generators internal analyser may be re-transmitted to external peripherals using the 4-20mA linear analogue output. The output is a linear current source, with 10 bit resolution, which increases from 4mA (Zero Oxygen) to 20mA (Full Scale Deflection). The FSD of the internal analyser is factory set to a default value of twice the generators specified purity. For % purity generators the maximum FSD is set to 6%.

Note: The oxygen purity setting of the generator is marked on the rating plate.

The table below shows the correlation between the purity settings of the generator and the output current. The FSD can be altered in menu 3.9of the control software (refer to “Customer Settings ” on page 25 of this guide for details).

GENERATOR PURITY	FULL SCALE DEFLECTION			RESOLUTION		
	4mA	-	20mA		=	
10ppm	0	-	20ppm	1ppm	=	0.8mA
100ppm	0	-	200ppm	1ppm	=	0.08mA
250ppm	0	-	500ppm	1ppm	=	0.032mA
500ppm	0	-	1000ppm	0.01ppm	=	0.016mA
0.1%	0	-	0.2%	0.01ppm	=	0.8mA
0.5%	0	-	1%	0.01ppm	=	0.16mA
1%	0	-	2%	0.01ppm	=	0.08mA
2%	0	-	4%	0.01ppm	=	0.04mA
3%	0	-	6%	0.01ppm	=	0.026mA
4%	0	-	6%	0.01ppm	=	0.026mA
5%	0	-	6%	0.01ppm	=	0.026mA

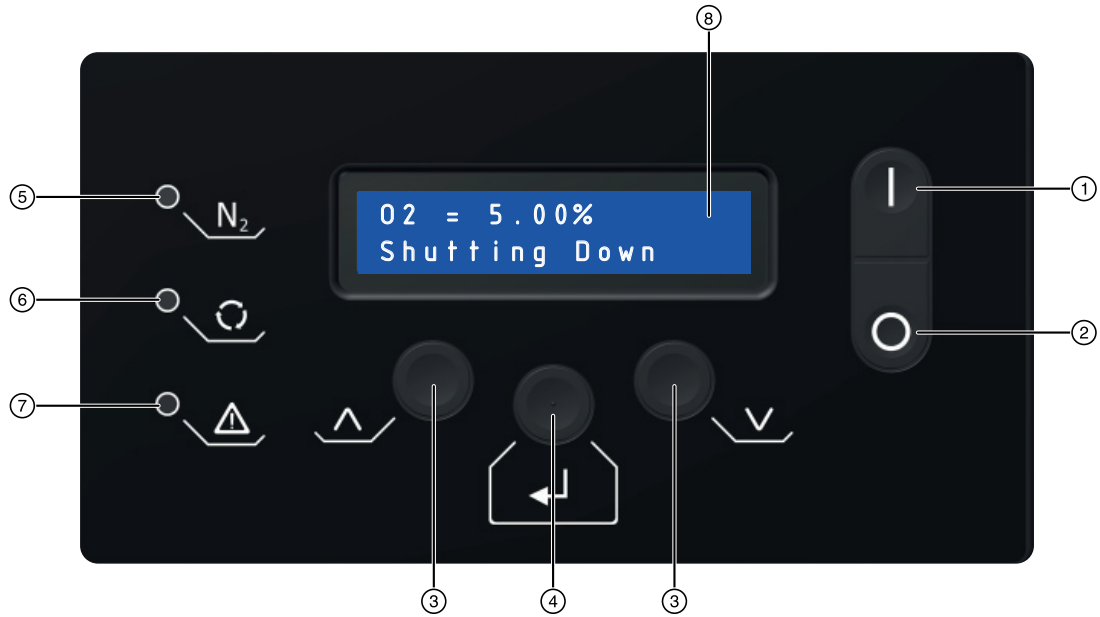

OPERATING THE GENERATOR

OVERVIEW OF THE CONTROLS



REF	DESCRIPTION	REF	DESCRIPTION	REF	DESCRIPTION	REF	DESCRIPTION
1	Start key	3	Menu navigation keys	5	Operating status indicator Green = Running, Yellow = Starting up / Shutting down Red - Standby	7	Service / Fault indicator Yellow = Service due Red = Fault
2	Stop key	4	Enter key	6	Economy / EST status indicator Green = Economy or EST Mode	8	LCD Display



STARTING THE GENERATOR

- 1 Inspect all of the system connection points and verify that they are secure.
- 2 With both the inlet and outlet ball valves of the buffer vessel closed, open the ball valve on the air inlet port to allow the compressed air into the generator.
- 3 Switch the electrical power on to the generator and wait whilst it runs through the controller initialisation routine.
- 4 If the generator was in standby mode when the electrical power was removed it will default to standby mode on completion of the initialisation routine. 
- 5 Press **1** to initiate the start up routine.
If the start clean up option is enabled the generator will run through the Rapid Cycle before opening the buffer valve and the N₂ outlet valve. The clean up cycle, which takes approximately 160 seconds, is designed to clean the CMS bed of impurities, bring the generator up to production purity more rapidly, and prevent poor quality gas flowing into the buffer. If the generator was running when the electrical power was removed (e.g. power failure) it will automatically run through a start up cycle (if enabled) and then commence normal operation. Wait until this cycle is complete and the menu displays "Running". This may take several minutes for ppm generators. 
- 6 Partially open the ball valve on the inlet to the buffer vessel to allow it to pressurise slowly. When the pressure gauge on the buffer vessel reads within 0.5 barg (7psig) of the inlet pressure, check for leaks in the buffer vessel inlet piping and then fully open the ball valve.
- 7 Open the ball valve on the outlet of the buffer vessel and check for leaks in the piping between the vessel and the generator.
- 8 Open the ball valve on the Nitrogen outlet.

Note: If the purity of the gas is not within specification it will be vented to atmosphere through a vent solenoid within the generator and not delivered to the application. When the required purity is achieved the gas will be delivered to the application.

STOPPING THE GENERATOR

- 1 Close the ball valve on the N₂ Outlet port.
- 2 Press **0** to initiate the shutting down sequence.
The generator will complete the current cycle and then exhaust both beds. This may take several minutes particularly on ppm generators.
- 3 When the generator is depressurised it will revert to standby mode.

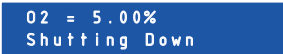

MENU INTERFACE

All of the operational parameters and data are accessed through the menu driven interface.

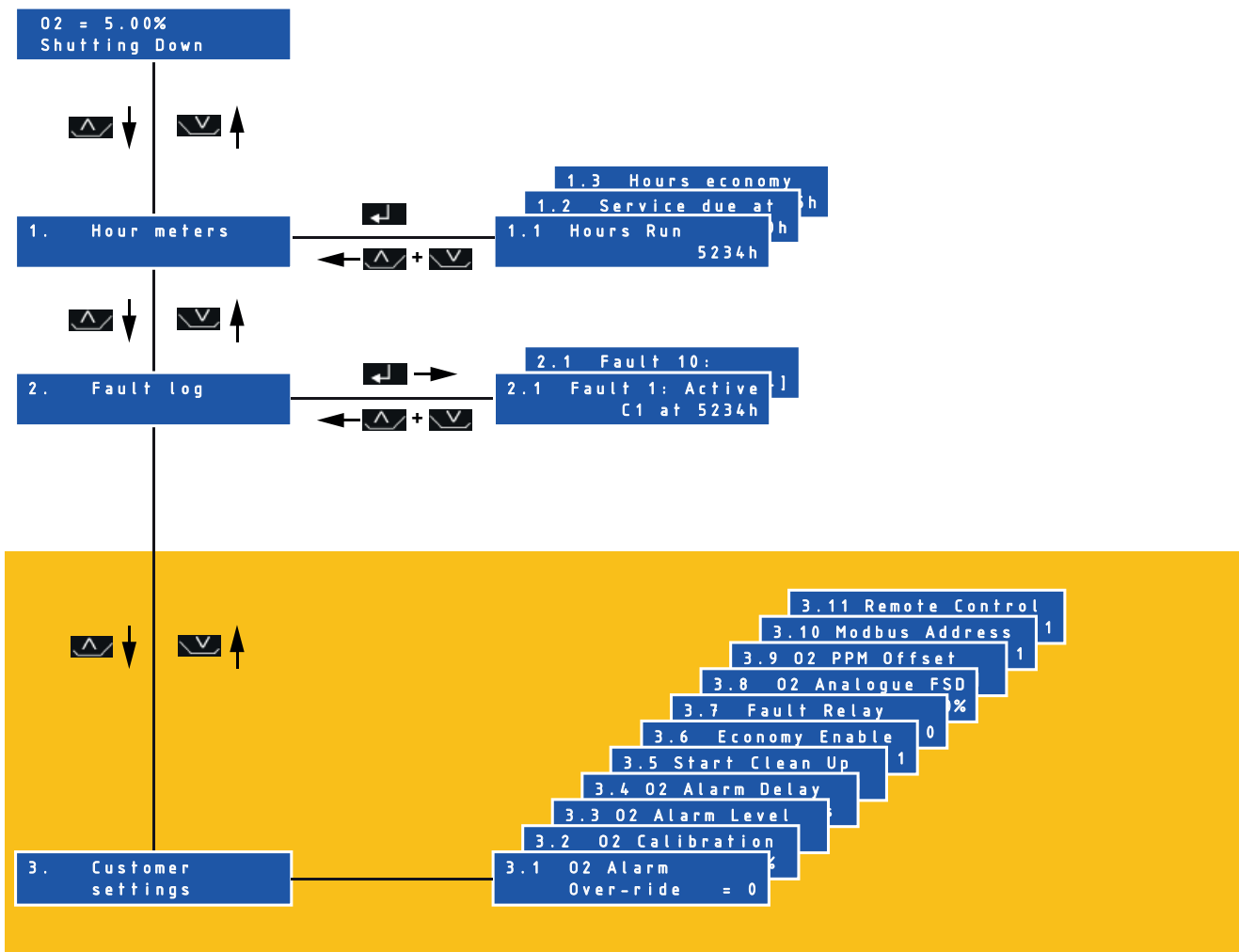

The interface will automatically default back to the main operating menu if no key activity has been detected for one minute.

Note: After an additional two minutes of inactivity the display will darken. To brighten the display press **↵**.

HOUR METERS

There are four hour meters available for viewing:

1.1	Hours run	5234h
1.2	Service due at	8000h
1.3	Hours economy	25h

The time in hours that the generator has been producing gas.

The time in operating hours that the generator can produce gas before a service is required.

The time in hours that the generator has been operating in Economy mode.

FAULT LOG

The fault log menu allows the user to access the 10 most recent fault messages.

```
2.1 Fault 1: Active
C1 at 5234h
```

Each fault is represented by a fault code and is displayed along with the run hours at which the fault occurred. If a fault is active the fault code displayed will flash. Any faults that are active when the power is switched off, and are still active when the power is re-applied, will cause a new entry to be added into the fault log.

The following codes are used within the system:

Fault Codes		Notes
C1	Pressure Start Inhibit	Low inlet pressure. Inhibits start.
P1	Inlet Pressure Fault	Low inlet pressure during cycling.
P2	Pressure Sensor Fault	Pressure sensor communication error.
E1	Power Failure	
Y1	O ₂ Alarm	
Y2	O ₂ Communication Failure	Communication fault between O ₂ analyser and control board
Y3	Incorrect Cell Selected	
Y4	O ₂ High (out of range)	Occurs when O ₂ > 25% (% generators) / O ₂ > 1.05% (ppm generators)
Y5	O ₂ Zero Drift Error	Contact Parker
S1	Service Due	

Note. Any faults that are active when the power is switched off, and remain active when the power is re-applied, will cause a new entry to be added into the fault log.

CUSTOMER SETTINGS



To prevent unauthorised access to the configurable parameters, the customers setting menu has optional password protection. This is disabled by default and can be enabled in menu 3.1

To gain access in to this menu, when password has been enabled:

Press and hold both the  and  keys for approximately 5 seconds until the menu changes to the password prompt as shown.



The flashing cursor will be positioned over the first digit. Using the  key change the first digit of the code and press . The cursor will move to the next digit.

Repeat the process and enter the following password 1 2 1 _ _ . When the password has been entered correctly the Hour Meters menu will be displayed. Use the  key to navigate to page 3 "Customer Settings" menu and press .

3.1 O2 Alarm
Over-ride = 0

When enabled the Oxygen alarm is over-ridden.
0 = Over-ride disabled, 1 = Override Enabled [OVR]

3.2 O2 Calibration
= 5.00%

Outlet oxygen sensor calibration menu.

3.3 O2 Alarm Level
= 5.05%

Sets the purity level at which an oxygen fault is initiated.
Default Settings:
% Generators - 0.05% above the selected production purity.
ppm Generators - 5ppm above the selected production purity.
If the purity level exceeds the oxygen alarm level for a period longer

3.4 O2 Alarm Delay
= 60s

If the purity level exceeds the oxygen alarm level for a period longer than the alarm delay, the oxygen alarm will be activated and the gas will be vented to atmosphere.
Delay Range = 0 - 600 Seconds, Default = 60 Seconds

3.5 Start Clean Up
Enable = 1

When enabled the bed cleaning cycles will run whenever the generator is powered up, comes out of standby mode and economy mode.
0 = Disabled, 1 = Enabled

3.6 Economy Enable
= 1

Enables the economy mode.
0 = Disabled, 1 = Enabled

3.7 Fault Relay
On Stop = 0

When enabled the actuation of the Stop control will generate an alarm.
0 = Disabled, 1 = Enabled

3.8 O2 Analogue FSD
= 6.00%

Sets the Full Scale Deflection value for the 4 - 20mA Analogue Output of the Oxygen sensor(s).

3.9 O2 PPM Offset
= [---]

Sets the ppm O2 cell calibrated offset value marked on the cell.
Note: This value must be entered only when the cell is changed.



3.10 Modbus Address
= 1

Sets the address for the generator when communicating on a network via the RS485 MODBUS port.
Address range is 1 - 32

3.11 Remote Control
= 1



Sets the mode of control for the generator
1 = Local Start / Stop control, 2 = Remote Start / Stop control via the digital input, 3= Remote communication

CHANGING PARAMETERS

Use the  and  keys to scroll through to the desired menu and press .



The flashing cursor should be positioned over the “=” sign to indicate that the parameter may be changed.



Use the  or  keys to change the parameter.

Press  to accept the changes or press  and  simultaneously to cancel the changes.



Press  and  simultaneously to return to the customer settings menu and then again to return to the main operating menu.



OXYGEN CONTENT

The residual oxygen content of the N₂ process gas is continually monitored during normal operation. If the oxygen content increases above the alarm level the nitrogen gas is vented to atmosphere at a reduced flow until the purity recovers.

ECONOMY MODE

Economy mode is designed to switch the generator into standby mode when there is no demand for gas. The generator monitors the outlet pressure and, if it exceeds a pre-determined level for a sustained period of time (Economy Period*), the N₂ outlet valve will close. The generator will continue to cycle as normal without delivering gas to the application. If the back pressure is maintained for an additional 5 minutes, the generator will stop cycling and enter Economy mode. If at any time the pressure falls below the regulated outlet pressure, the generator will resume normal operation. If the generator is in economy shutdown when the pressure falls it will complete the cycle and then run through the a clean up cycle prior to going back online.



Warning

The economy mode can be disabled within the customer settings menu, however Parker strongly recommend that this option remains enabled.















The Economy over-ride facility (optional) can be used to maintain the beds when the generator is in economy mode. If the over-ride is enabled, a clean up cycle will be performed once every 20 minutes (default). This allows the generator to go straight on-line when the outlet pressure falls below the regulated outlet pressure. *The Economy Period is factory set to 5 minutes.

SERVICING THE GENERATOR

CLEANING

Clean the equipment with a damp cloth only and avoid excessive moisture around any electrical sockets. If required you may use a mild detergent, however do not use abrasives or solvents as they may damage the warning labels on the equipment.

SERVICE INTERVALS

Description of Service Required		Service Recommended Every:				
Component	Operation	Daily	Weekly	3 Months	12 Months	24 Months
Generator	Check status indicators located on the control panel					
Generator	Check regulated outlet pressure					
Generator	Check O2 purity					
System	Check filter drains					
System	Check inlet air quality					
Generator	Check for air leaks					
Generator	Check pressure gauges during purging for excessive back pressure					
Generator	Check condition of electrical supply cables and conduits					
Generator	Check cyclic operation					
O2 Cell	Calibrate Oxygen Cell					
Generator	Replace the mist-x silencer					
Filtration	Replace the buffer tank filter					
Generator	Replace / Calibrate the oxygen sensor					
Generator	Replace / Service valves					

Key

	Check		Recommended Service
---	-------	---	---------------------

SERVICE KITS

Recommended every 12 months



Catalogue No's	Description	Contents
M12.N2C.0001	Kit: 12 month N2 Compact service	Mist-X 150 silencer P010A0 element

Recommended every 24 months

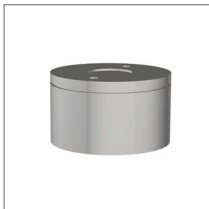

Catalogue No's	Description	Contents
M24.PPM.0002	Kit: O2 Cell PPM	O2 Cell PPM
M24.PCT.0002	Kit: O2 Cell %	O2 Cell %



Catalogue No's	Description	Contents
M24.N2C.0001	Kit: 24 Month N2C valve overhaul (with Analyser)	Outlet Valves x2 Air inlet valve x2 Exhaust valve x2



Catalogue No's	Description	Contents
M24.N2C.0002	Kit: 24 Month N2C valve overhaul (without Analyser)	Outlet Valves x1 Air inlet valve x2 Exhaust valve x2

EXHAUST SILENCER REPLACEMENT

The exhaust silencer is located under the inlet manifold assembly.

Unscrew the element from the exhaust port (01) and discard (02).

Fit the replacement element ensuring that it is fully engaged onto the pipe fitting and secure it hand tight.

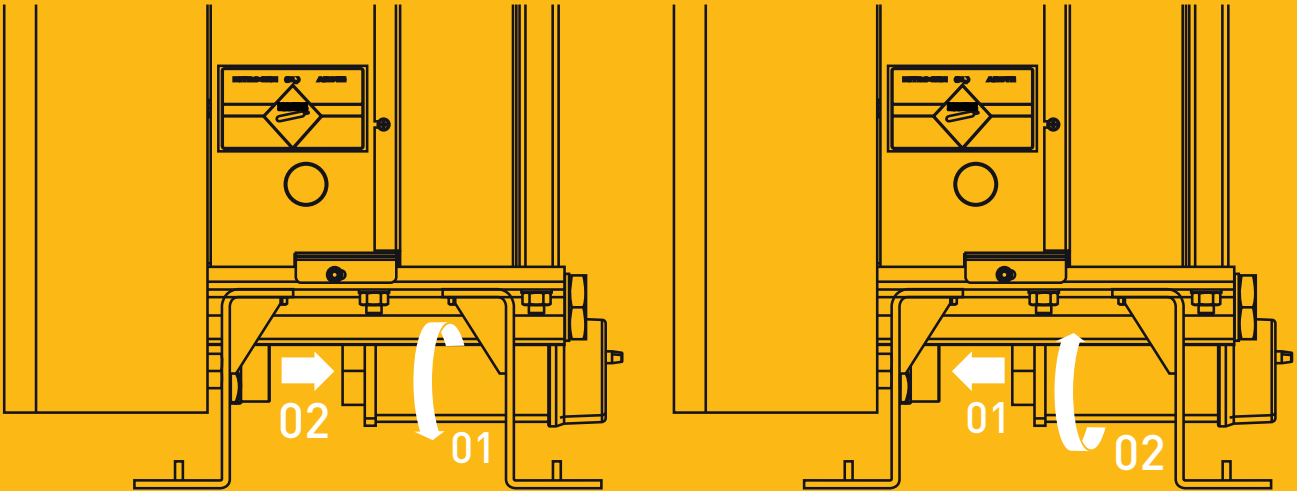

OXYGEN CELL REPLACEMENT

Unscrew the oxygen cell lead (01) and solenoid plugs (02) then remove the 4-20mA connections and move the lead to prevent obstruction. Disconnect the tubing from the 3-way ball valve (03) to the regulator (04). Loosen the regulator retaining collar (05) then unscrew the top retaining screw (06) of the assembly and remove. Cut the tie wrap and unscrew the oxygen sensor. Remove the used cell and replace with the new one.

Note: Ensure to wear gloves when handling the new cell to prevent causing any damage.

Refit in reverse order.

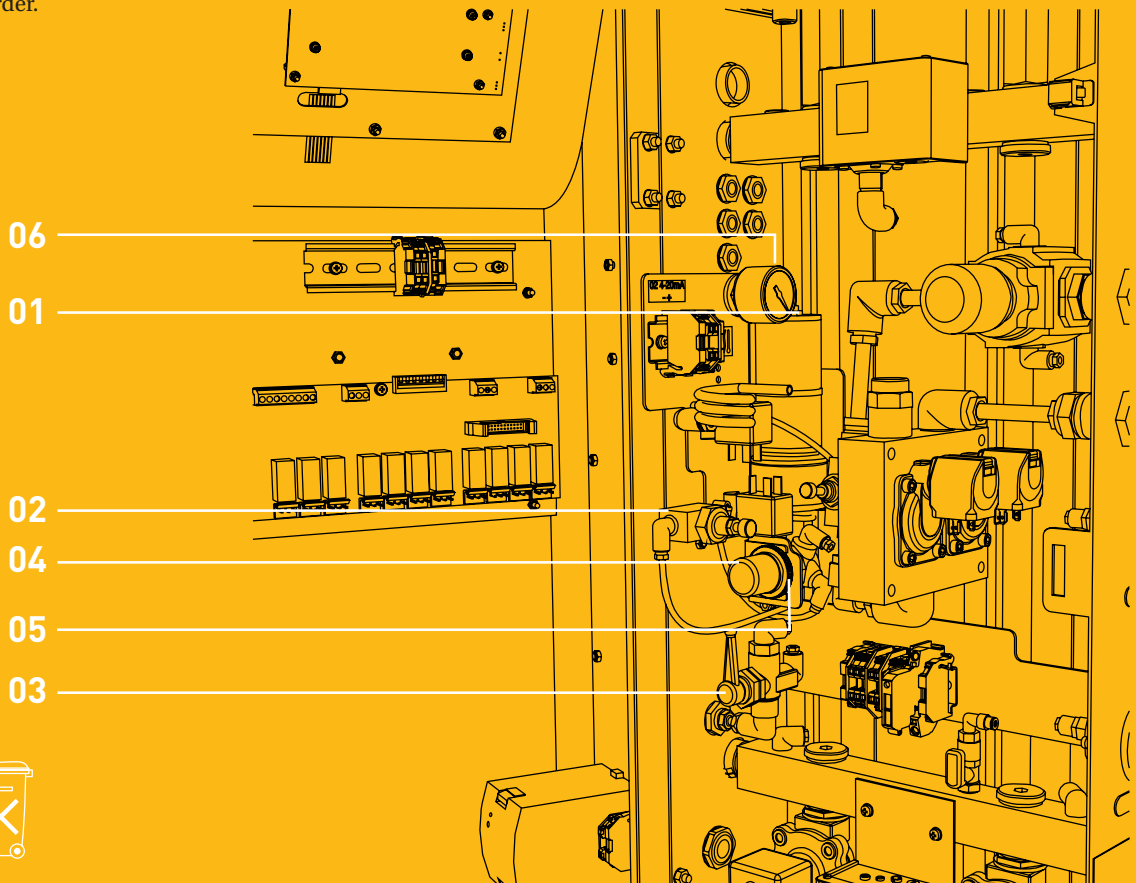

OXYGEN ANALYSER CALIBRATION



Warning

Hot surfaces and hazardous live terminals. Take care when performing the following calibration procedure as there are hazardous live voltages and potentially hot surfaces within the enclosure.

The O₂ analyser should be calibrated at least once every three months against a calibrated gas supply or a calibrated independent analyser.

For low purity applications the calibration may be performed using compressed air, however this method is not recommended when the purity of the gas is critical.

The purity of the calibration gas should not exceed 50ppm for high purity generators (ppm oxygen cells) and 5% for lower purity generators (% oxygen cells). Do not exceed 7 barg pressure.



Caution

The pressure regulator and flow control valve are factory set to deliver 250cc/min. to the O₂ cell. Adjusting either component could cause damage to the O₂ cell or incorrect calibration.

USING A CALIBRATED GAS SUPPLY

- Select menu 3.1 and enable the O₂ Alarm Over-ride.
- Connect the gas supply to the O₂ Analyser calibration port (1) on the side of the generator.
- Locate the calibration ball valve (2) inside of the shroud and rotate the handle clockwise so that it is pointing down as shown.
- Wait for the O₂ reading to stabilise before entering the calibrated level.

USING A CALIBRATED INDEPENDENT ANALYSER

- Select menu 3.1 and enable the O₂ Alarm Over-ride.
- Connect the analyser to the nitrogen outlet port of the generator.
- Wait approximately for the O₂ reading to stabilise before entering the calibrated level.

USING COMPRESSED AIR

- Select menu 3.1 and enable the O₂ Alarm Over-ride.
- Connect the O₂ sample line between the elbow push in fitting, located on the ball valve (3), and the O₂ Analyser calibration port (1).



Warning

If a sample line other than the one provided by Parker is used ensure that it is suitable rated for the working pressure of the generator.

- Open the ball valve (3) and rotate the handle of the calibration ball valve (2) so that it is pointing downwards as shown.
- Wait for the O₂ reading to stabilise before entering the calibrated level.





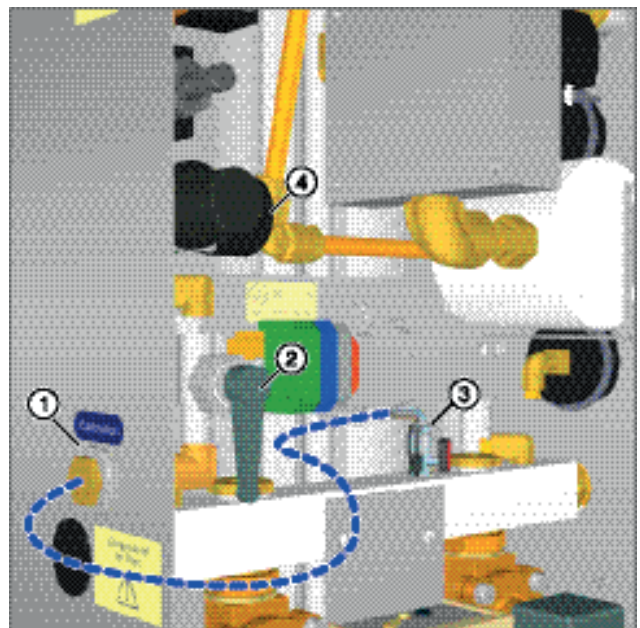

Warning

The sample line will need to be depressurised prior to disconnection. Close the ball valve (3) and wait until the pressure shown on the pressure gauge (4) reaches zero. When the line is fully depressurised, rotate the handle of the calibration ball valve (2) so that it is pointing upwards and disconnect the line from the generator.



ENTERING THE CALIBRATED LEVEL

- Navigate to menu 3.2 and press .
- Using the  and  keys enter the purity of the calibration gas.
- Press  to send the calibration level to the O₂ Analyser.
- On successful completion of the calibration the new O₂ reading will be shown on the bottom line of the display.
- If the calibration is not successful the original reading from the analyser will be loaded. Should this occur repeat the above steps.
- On completion of the calibration, return the ball valves back to their original position and remove the regulated calibration gas supply as applicable.
- Navigate to menu 3.1 and disable the O₂ Alarm Over-ride.
- When returning to the main operating menu, "CAL" will be shown on the top line of the display. This will remain for a period of twenty minutes after the calibration. Throughout this time period the O₂ alarm is overridden, to allow the sensor(s) to return to the required level.

FILTER DEPRESSURISATION

Close the ball valves located on the inlet and outlet ports of the filter and depressurise it by opening the manual drain on the filter bowl (01).

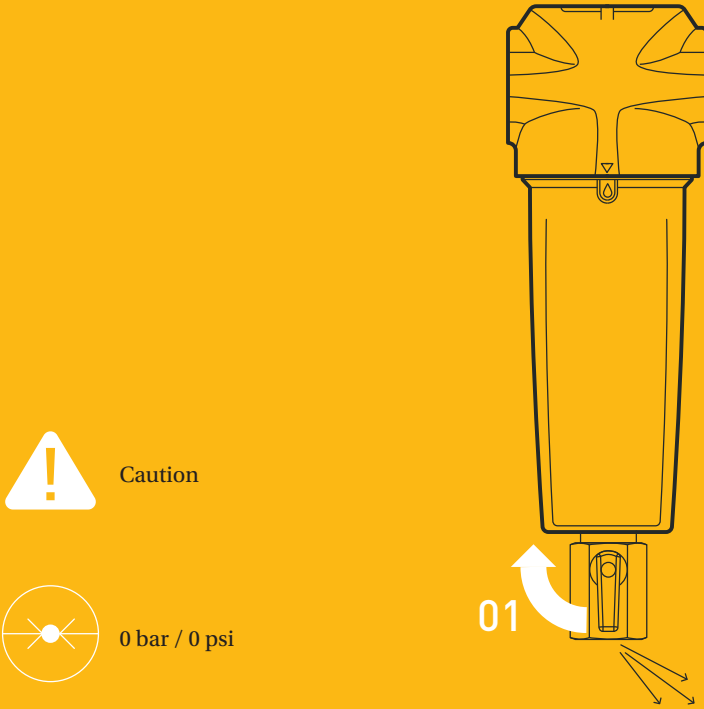

FILTER BOWL REMOVAL

Unscrew the filter bowl (01 & 02) and remove the used element (03).
Note: A strap wrench may be required for the removal of the 050 & 055 filter bowl.

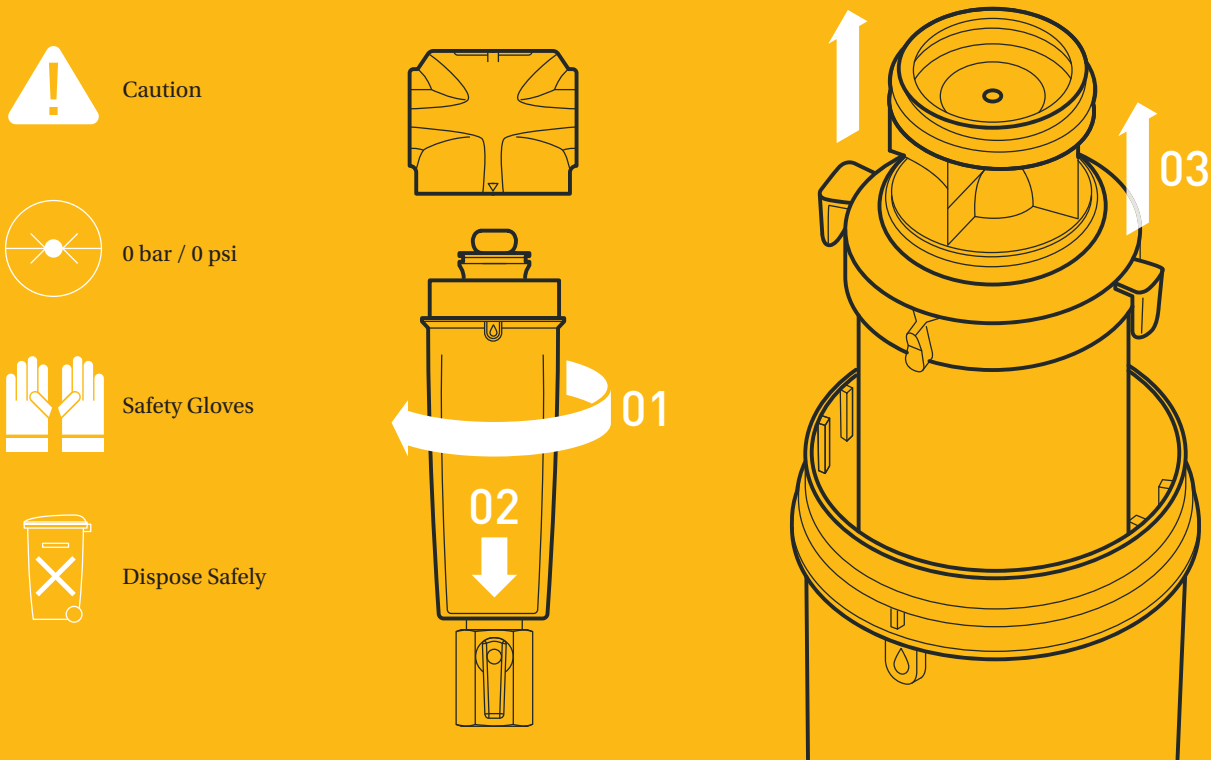

INSERTION OF REPLACEMENT ELEMENT INTO FILTER BOWL

Insert the new element into the filter bowl ensuring that the lugs are seated correctly in the grooves.

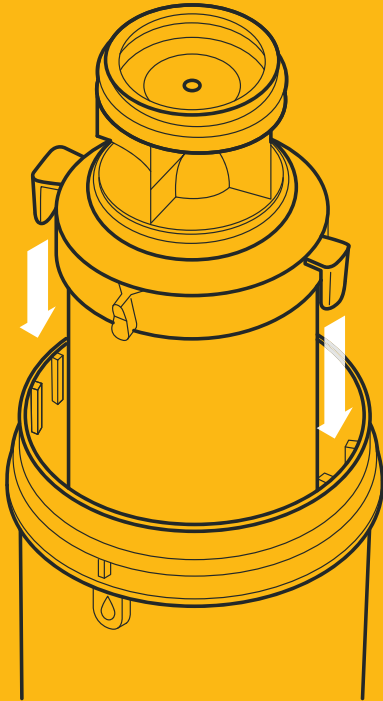

REPLACEMENT OF FILTER HEAD O RING

Replace the O-ring located in the filter head with the new O-ring provided.



Ensure to lubricate the O-ring and threads with a suitable acid free Petroleum jelly.

RECONNECTING THE FILTER BOWL WITH HEAD

Refit the filter bowl and head ensuring that the threads are fully engaged (01) and the locking details are aligned (02).

Note: To ensure that the bowl is fully engaged into the head, the 010 bowl requires 360° of rotation until the thread stop.

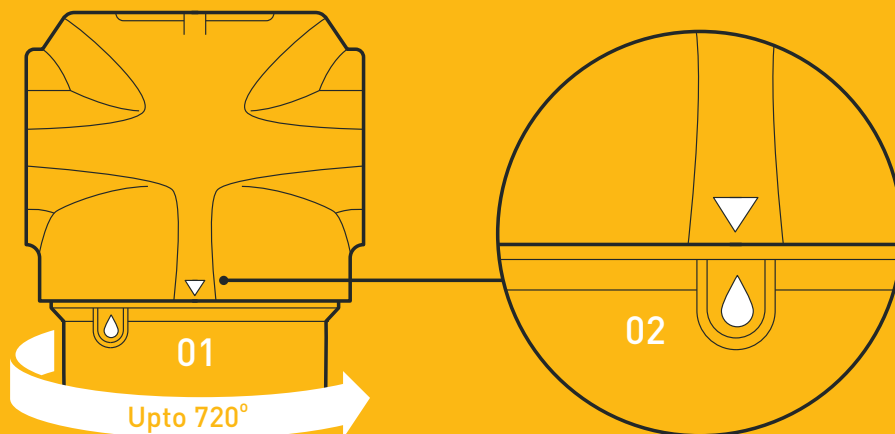

TECHNICAL SPECIFICATION

DESCRIPTION

The N₂ Compact range of nitrogen generators operate on the Pressure Swing Adsorption (PSA) principle to produce a continuous stream of nitrogen gas from clean dry compressed air.

Dual chamber columns, filled with extruded beads of adsorbent (Carbon Molecular Sieve [CMS]) material, are joined via an upper and lower manifold to produce a two bed system. Compressed air enters the bottom of the 'on-line' bed and flows up through the CMS. The oxygen, carbon dioxide, humidity and non-methane hydrocarbons are preferentially adsorbed by the CMS allowing clean dry nitrogen to pass through.

After a pre-set time the control system automatically switches the bed to regenerative mode. All of the contaminants are vented from the CMS and a small portion of the outlet nitrogen gas is expanded into the bed to accelerate the regeneration. At the same instant the second bed comes on-line and takes over the separation process.

The CMS beds alternate between separation and regeneration modes to ensure continuous and uninterrupted nitrogen production.

The oxygen concentration in the nitrogen stream is analysed continuously. If the concentration exceeds the required production level, the nitrogen outlet is closed and the gas is vented to atmosphere. Normal operation will resume when the purity recovers.

TECHNICAL SPECIFICATION

	UNITS	10PPM	100PPM	0.1%	0.5%	1%	2%	3%	4%	5%
Flowrate										
N2C-2	M ³ /HR	0.81	1.54	2.48	3.69	4.39	6.11	7.73	9.13	10.29
	CFM	0.5	0.9	1.5	2.2	2.6	3.6	4.5	5.4	6.1
N2C-4	M ³ /HR	1.73	2.94	4.96	7.58	9.12	12.95	15.89	18.38	20.57
	CFM	1.0	1.7	2.9	4.5	5.4	7.6	9.4	10.8	12.1
N2C-6	M ³ /HR	2.41	4.46	7.59	11.06	13.32	18.64	22.68	26.06	29.04
	CFM	1.4	2.6	4.5	6.5	7.8	11.0	13.3	15.3	17.1
N2C-8	M ³ /HR	3.38	5.89	10.24	14.86	18.01	24.02	29.33	33.93	37.81
	CFM	2.0	3.5	6.0	8.7	10.6	14.1	17.3	20.0	22.3
Air to N2										
N2C-2 to N2C-8		7.0	5.3	3.9	3.2	3.0	2.5	2.3	2.1	2.0
Outlet Pressure										
N2C-2	BAR G	5.4	5.5	5.6	5.6	6.0	5.9	5.8	5.5	5.3
	PSI G	78.3	79.8	81.2	81.2	87.0	85.6	84.1	79.8	76.9
N2C-4	BAR G	5.4	5.5	5.6	5.6	6.0	5.9	5.8	5.5	5.3
	PSI G	78.3	79.8	81.2	81.2	87.0	85.6	84.1	79.8	76.9
N2C-6	BAR G	5.4	5.5	5.6	5.6	6.0	5.9	5.8	5.5	5.3
	PSI G	78.3	79.8	81.2	81.2	87.0	85.6	84.1	79.8	76.9
N2C-8	BAR G	5.4	5.5	5.6	5.6	6.0	5.9	5.8	5.5	5.3
	PSI G	78.3	79.8	81.2	81.2	87.0	85.6	84.1	79.8	76.9

Stated flows are for operation at 7 bar g (100 psi g / 0.7 MPa g) with reference to 25°C

INLET PARAMETERS

Inlet Air Quality	ISO 8573-1:2001 Class 2.2.1
Inlet Pressure	6 - 10 bar g 87 - 145 psi g
Inlet Temperature	5 - 50°C (41 - 122°F)

PORT CONNECTIONS

Air Inlet	G1/2
N ₂ Outlet to Buffer	G1/2
N ₂ Inlet from Buffer	G1/2
N ₂ Outlet	G1/2

ELECTRICAL PARAMETERS

Generator Supply*	115 / 230 ± 10% Vac 50/60 Hz
Generator Power**	80W
Fuse	3.15 A (Anti Surge (T), 250v, 5 x 20mm HBC, Breaking Capacity 1500A @ 250v, IEC 60127, UL R/C Fuse)
Max Dryer Power***	100W

Notes:

* The generator does not require adjustment when connecting to 115v and 230v electrical supplies.

** The power rating specified is for the generator alone and does not take in to account any pre-treatment dryer connected to the dryer supply terminals of the generator.

*** The dryer is fed directly from the generator supply.

ENVIRONMENTAL PARAMETERS

Ambient Temperature	5 - 50°C (41 - 122°F)
Humidity	29% @ 50°C (80% max ≤ 31°C)
IP Rating	IP20 / NEMA 1
Pollution Degree	2
Installation Category	II
Altitude	< 2000 m (6562 ft)
Noise	<80 dB (A)

PACKED WEIGHTS AND DIMENSIONS

	Dimensions mm / (ins)			Weight kg / (lbs)
	L	W	D	
N2C-2	758 (29.84)	548 (21.57)	1215 (47.83)	135.5 (298.7)
N2C-4	808 (31.81)	548 (21.57)	1215 (47.83)	188 (414.5)
N2C-6	978 (38.5)	548 (21.57)	1215 (47.83)	246 (542.3)
N2C-8	1147 (45.16)	548 (21.57)	1215 (47.83)	303 (668)

GENERATOR WEIGHTS AND DIMENSIONS

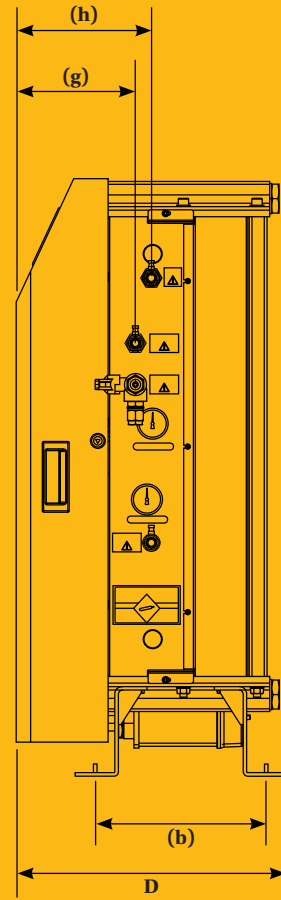
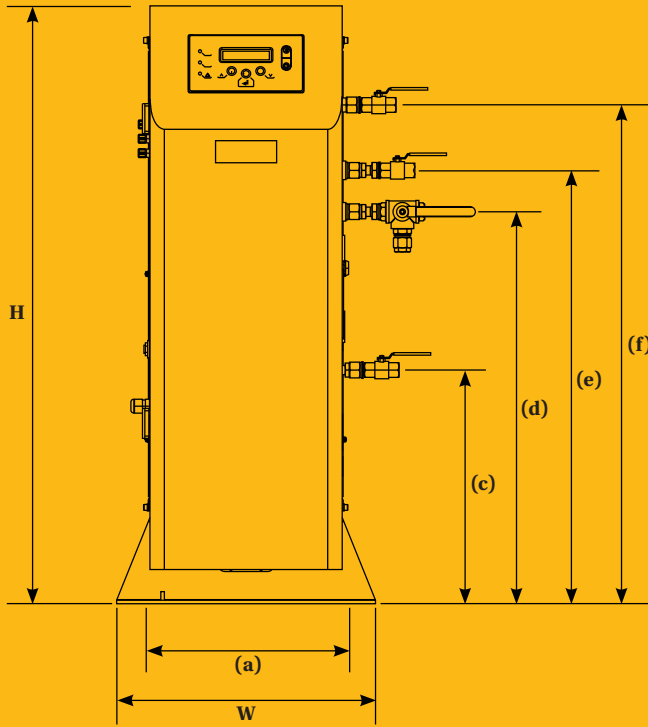

MODEL	DIMENSIONS MM / (INS)											Weight Kg / (lbs)
	H	W	D	(a)	(b)	(c)	(d)	(e)	(f)	(g)	(h)	
N2C-2	1040 (40.9)	450 (18)	458 (18.03)	375 (14.76)	297 (11.71)	406.5 (16)	681.5 (26.83)	753.5 (29.66)	868.5 (34.19)	207.5 (8.17)	237.5 (9.35)	98 (216.1)
N2C-4	1040 (40.9)	450 (18)	628 (27.72)	375 (14.76)	466.5 (18.37)	406.5 (16)	681.5 (26.83)	753.5 (29.66)	868.5 (34.19)	207.5 (8.17)	237.5 (9.35)	145 (319.7)
N2C-6	1040 (40.9)	450 (18)	796 (31.34)	375 (14.76)	635 (25.02)	406.5 (16)	681.5 (26.83)	753.5 (29.66)	868.5 (34.19)	207.5 (8.17)	237.5 (9.35)	196 (432.1)
N2C-8	1040 (40.9)	450 (18)	965 (37.99)	375 (14.76)	804 (31.67)	406.5 (16)	681.5 (26.83)	753.5 (29.66)	868.5 (34.19)	207.5 (8.17)	237.5 (9.35)	

TROUBLESHOOTING

In the unlikely event that a problem occurs on the equipment, this troubleshooting guide can be used to identify the probable cause and remedy.



Warning

Troubleshooting should only be attempted by competent personnel. All major repair and calibration work should be undertaken by a Parker trained, qualified and approved engineer.

FAULT	PROBABLE CAUSE	REMEDY
Power connected but the status indicators and display (analyser only) is not illuminated.	The electrical power to the generator is not connected.	Check that there is power to the generator supply terminals on terminal block "TB1".
	The electrical supply fuse is blown.	Check fuse "F1" on terminal block "TB1". If the fuse has blown disconnect the electrical supply to the generator and replace the fuse.
	The controller ribbon cable is not connected.	Open the access door and check that the 26-way ribbon cable is connected between the controller and JP22 on the control board.
No / Low gas outlet pressure	External leak.	Check the piping and connection points for leaks. Repair as necessary.
	Internal leaks.	Open the access door and check all connection points for leaks. Repair as necessary.
	The pressure of the compressed air supply is low.	Refer to Low inlet pressure fault below.
	The generator requires a service.	Check the service schedule and perform the required service.
High Oxygen concentration.	Defective Oxygen cell.	Replace the oxygen cell.
	Leak in system piping.	Open the access door and check all connection points for leaks. Repair as necessary.
Low inlet pressure	The pre-filtration within the system is approaching the end of its operational life.	Check the service schedules for the filters and perform the required service.
	The pretreatment dryer is being overflowed or is operating at a reduced system pressure.	Check that compressed air delivered to the dryer meets the requirements specified within the documentation provided with the dryer.
	An isolation valve is partially closed upstream of the generator.	Check the position of all isolation valves.
	External leak.	Check the piping and connection points for leaks. Repair as necessary.
Excessive noise or vibration	Silencer loose or defective.	Check that the exhaust silencer is securely fitted in place.
	Solenoid valve wear or coil loose.	Check the exhaust valves and verify that the coils are secure. Contact Parker for advice.
High outlet pressure.	Outlet regulator is incorrectly set or is defective.	Contact Parker for advice.
Moisture in the gas at the outlet of the generator.	Blocked exhaust.	Contact Parker for advice.
	The CMS is beyond its operation life.	Contact Parker for advice.
Reduced flow at the outlet of the generator.	The flow controller is incorrectly set.	Contact Parker for advice.
	The dust filter on the receiver outlet is blocked.	Contact Parker for advice.
	Faulty or incorrectly set pressure regulators.	Contact Parker for advice.

PARKER WORLDWIDE

AE – UAE, Dubai
Tel: +971 4 8127100
parker.me@parker.com

AR – ARGENTINA, Buenos Aires
Tel: +54 3327 44 4129

AT – AUSTRIA, Wiener Neustadt
Tel: +43 (0)2622 23501-0
parker.austria@parker.com

AT – EASTERN EUROPE, Wiener Neustadt
Tel: +43 (0)2622 23501 900
parker.easteurope@parker.com

AU – AUSTRALIA, Castle Hill
Tel: +61 (0)2-9634 7777

AZ – AZERBAIJAN, Baku
Tel: +994 50 2233 458
parker.azerbaijan@parker.com

BE/LU – BELGIUM, Nivelles
Tel: +32 (0)67 280 900
parker.belgium@parker.com

BR – BRAZIL, Cachoeirinha RS
Tel: +55 51 3470 9144

BY – BELARUS, MINSK
Tel: +375 17 209 9399
parker.belarus@parker.com

CA – CANADA, Milton, Ontario
Tel: +1 905 693 3000

CH – SWITZERLAND, Etoy
Tel: +41 (0)21 821 87 00
parker.switzerland@parker.com

CL – CHILE, Santiago
Tel: +56 2 623 1216

CN – CHINA, Shanghai
Tel: +86 21 2899 5000

CZ – CZECH REPUBLIC, Klecany
Tel: +420 284 083 111
parker.czechrepublic@parker.com

DE – GERMANY, Kaarst
Tel: +49 (0)2131 4016 0
parker.germany@parker.com

DK – DENMARK, Ballerup
Tel: +45 43 56 04 00
parker.denmark@parker.com

ES – SPAIN, Madrid
Tel: +34 902 330 001
parker.spain@parker.com

FI – FINLAND, Vantaa
Tel: +358 (0)20 753 2500
parker.fi nland@parker.com

FR – FRANCE, Contamine s/Arve
Tel: +33 (0)4 50 25 80 25
parker.france@parker.com

GR – GREECE, Athens
Tel: +30 210 933 6450
parker.greece@parker.com

HK – Hong Kong
Tel: +852 2428 8008

HU – HUNGARY, Budapest
Tel: +36 1 220 4155
parker.hungary@parker.com

IE – IRELAND, Dublin
Tel: +353 (0)1 466 6370
parker.ireland@parker.com

IN – INDIA, Mumbai
Tel: +91 22 6513 7081-85

IT – ITALY, Corsico (MI)
Tel: +39 02 45 19 21
parker.italy@parker.com

JP – JAPAN, Tokyo
Tel: +81 (0)3 6408 3901

KR – SOUTH KOREA, Seoul
Tel: +82 2 559 0400

KZ – KAZAKHSTAN, Almaty
Tel: +7 7272 505 800
parker.easteurope@parker.com

LV – LATVIA, Riga
Tel: +371 6 745 2601
parker.latvia@parker.com

MX – MEXICO, Apodaca
Tel: +52 81 8156 6000

MY – MALAYSIA, Shah Alam
Tel: +60 3 7849 0800

NL – The Netherlands, Oldenzaal
Tel: +31 (0)541 585 000
parker.nl@parker.com

NO – NORWAY, Asker
Tel: +47 66 75 34 00
parker.norway@parker.com

NZ – NEW ZEALAND, Mt Wellington
Tel: +64 9 574 1744

PL – POLAND, Warsaw
Tel: +48 (0)22 573 24 00
parker.poland@parker.com

PT – PORTUGAL, Leca da Palmeira
Tel: +351 22 999 7360
parker.portugal@parker.com

RO – ROMANIA, Bucharest
Tel: +40 21 252 1382
parker.romania@parker.com

RU – RUSSIA, Moscow
Tel: +7 495 645-2156
parker.russia@parker.com

SE – SWEDEN, Spånga
Tel: +46 (0)8 59 79 50 00
parker.sweden@parker.com

SG – Singapore
Tel: +65 6887 6300

SK – SLOVAKIA, Banská Bystrica
Tel: +421 484 162 252
parker.slovakia@parker.com

SL – SLOVENIA, Novo Mesto
Tel: +386 7 337 6650
parker.slovenia@parker.com

TH – THAILAND, Bangkok
Tel: +662 717 8140

TR – TURKEY, Istanbul
Tel: +90 216 4997081
parker.turkey@parker.com

TW – TAIWAN, Taipei
Tel: +886 2 2298 8987

UA – UKRAINE, Kiev
Tel: +380 44 494 2731
parker.ukraine@parker.com

UK – UNITED KINGDOM, Warwick
Tel: +44 (0)1926 317 878
parker.uk@parker.com

US – USA, Cleveland
Tel: +1 216 896 3000

VE – VENEZUELA, Caracas
Tel: +58 212 238 5422

ZA – SOUTH AFRICA, Kempton Park
Tel: +27 (0)11 961 0700
parker.southafrica@parker.com

European Product Information Centre

Free phone: 00 800 27 27 5374

(from AT, BE, CH, CZ, DE, EE, ES, FI, FR, IE, IL, IS, IT, LU, MT, NL, NO, PT, SE, SK, UK)

ONE YEAR AIR QUALITY GUARANTEE

Your air quality has been guaranteed for 1 year and will be renewed at every annual filter element change.

Annual filter element changes ensure:

- Optimal performance is maintained
- Air quality continues to meet international standards
- Protection of downstream equipment, personnel and processes
- Low operational costs
- Increased productivity and profitability
- Peace of mind

PARKER HANNIFIN MANUFACTURING LIMITED

Gas Separation and Filtration Division EMEA
Dukesway, Team Valley Trading Est
Gateshead, Tyne and Wear
England NE11 0PZ

Tel: +44 (0) 191 402 9000

Fax: +44 (0) 191 482 6296

www.parker.com/gsf

