



Parker Legris :

LIQUIfit[®], Connection Solutions for Beverage & Fluids
From -10°C up to +150°C



ENGINEERING YOUR SUCCESS.



The Low Pressure Connectors Europe Division (formerly Legris) of Parker Hannifin, the global leader in motion and control technologies, has launched LIQUIfit®, a new “eco-designed” ranges of leak-free and compact push-in fittings, tubing and complementary products for liquid transfer applications.

The LIQUIfit® range is suitable for liquid transfer applications: food process, drinks dispensers, water purification systems...

This product range also benefits from a range extension of metal adaptors designed for liquid transfer applications.



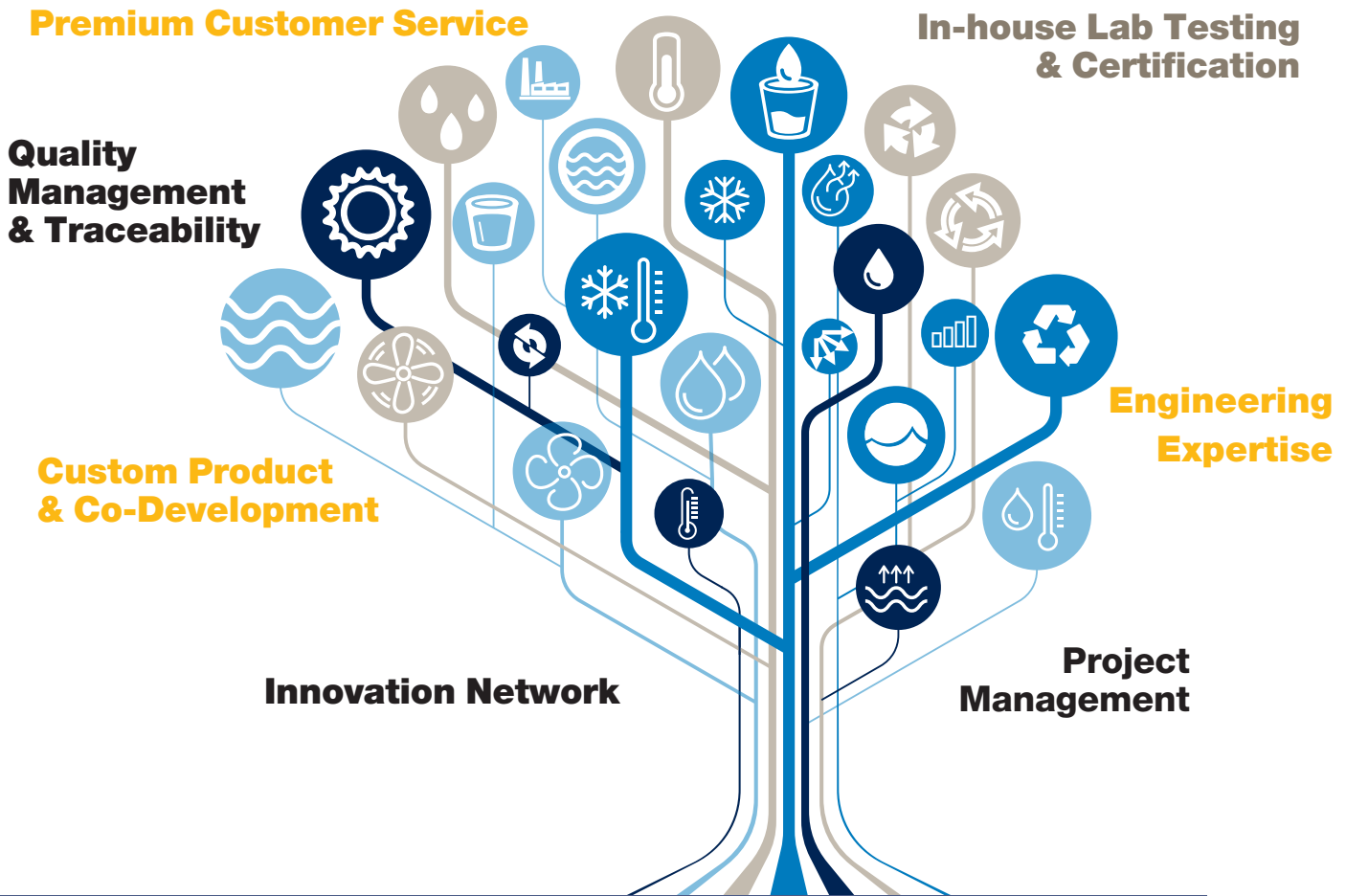

Parker Legris

Provider of Innovative Fluid Handling Solutions for Conveying Beverages and Fluids

Inventor of push-to-connect technology, we constantly strive to design, manufacture and customise easy-to-assemble innovative fluid handling solutions distributed anywhere across the globe.

Our Expertise

- In-house lab testing
- Quality management & traceability: ISO 9001 and IATF 16949
- 100% leak tested
- Solution provider

Food Liquids Applications

Water Treatment

Residential Treatment

- Filters
- Reverse Osmosis (RO)
- Softeners
- UV Treatment



Industrial Treatment

- Filtration Module
- Industrial Softeners-
- Desalination



Food Processing

- Food Splash Areas



Beverage Transfer

- Professional and Domestic Coffee Machines
- Vending Machines
- Brewery System
- Hot and Cold Drink Dispensers



Drinking Water

- Water Dispensers
- Water Coolers

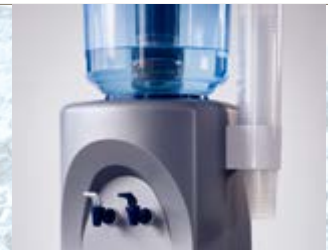

Directives and Regulations: the Parker Legris Offer

P. 6

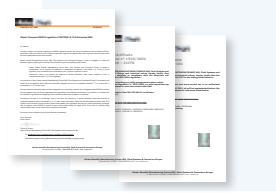

Together, We Can Build Sustainable Development

P. 7



Part Number Identification

P. 8



Product Ranges for Fluids and Beverages

P. 9

Range of LIQUIfit® Push-In Fittings

P. 12



Range of LIQUIfit® Push-In Fittings with Metal Adaptors

P. 28



Advanced PE Tubing

P. 32

Crystal PU Tubing

P. 34

FEP Tubing

P. 36



Range of LIQUIfit® Non-Return Valves

P. 34



Range of LIQUIfit® Ball Valves

P. 36



Directives and Regulations: the Parker Legris Offer

Parker Legris complies with the directives and regulations listed below and goes beyond its statutory obligations for the ranges in question.



European RoHS directives: 2011/65/EC
Relating to the limitation of the use of 6 hazardous substances in electrical and electronic equipment (mercury, lead, cadmium, hexavalent chromium, PBB and PBDE).



REACH regulation: no. 1907/2006
As product manufacturer, we are subject to article 33 of the regulation which defines a duty to inform when a candidate substance is present at more than 0.1% weight for weight.



Pressurised equipment directive: 97/23/EC
This directive regulates the design, manufacture and assessment of pressurised equipment to ensure operating safety.



ATEX directive: 94/9/EC mandatory since 01/07/2003
This directive is mandatory for electrical and non-electrical equipment used in explosive gaseous or dusty atmospheres. The use of our products in these areas must be determined in accordance with the ATEX environment.



Regulation 1935/2004
This framework regulation relates to materials and objects designed to come into contact with foodstuffs. It describes specific measures per product group (Art. 5).



CFR 21: Code of Federal Regulation Title 21: Food and Drugs
This code consists of lists of prohibited substances for materials intended to come into contact with foodstuffs.



NSF 51: NSF / ANSI-51
Fittings and tubes complying with this standard are tested and approved by NSF for contact with drinks and foodstuffs.



NSF 61: NSF / ANSI-61
Fittings and tubes complying with this standard are tested and approved by NSF for contact with drinking water.



NSF 42 and 58: NSF/ANSI-42/58
Tubes complying with this standard are tested and approved by NSF for drinking water treatment systems.



ACS: Attestation de Conformité Sanitaire (France)
Official approval issued by the Direction générale de la Santé Française (French Health Directorate), applies to constituent materials of equipment in contact with water intended for human consumption.

KTW

KTW: Kunststoffe und Trinkwasser (Germany)
Guidelines for the health evaluation of equipment in contact with drinking water, assessment and certification carried out by the TZW.

New Certificates

W270

W270: Food contact standard (Germany)
Standard describing a test method for determining the microbial growth on non-metal materials designed to come into contact with drinking water. Test and certification carried out by the TZW.



WRAS: Water Regulations Advisory Scheme (UK)
Fittings approved by this programme are declared compliant for water supply by WRc - NSF.



DM 174: Ministerial decree (Italy)
Declaration of hygiene compliance for equipment used for drinking water, tested and certified by the TIFQ.

The Parker Legris product range offers compliance with numerous European standards associated in particular with the directives and regulations referred to above. The official texts of these directives are available on the site: <http://eur-lex.europa.eu>.

Certificates and Regulations

Certificates of conformity for our products are available on our web site. Contact us for any further information you require.



Together, We Can Build Sustainable Development

Parker Legris, **ISO 14001 certified**, has made the conservation of resources and protection of the environment a major priority. We have incorporated improved environmental management as a permanent feature in the vision and mission of the company, aiming to benefit nature, technology and mankind.



Protecting natural resources

By saving energy through the performance of our production facilities.

Improving performance

By changing habits in order to promote new materials and concepts.

Asserting our values for the protection of the environment

By having all our sites **ISO 14001** certified in order to unify all our employees around clear objectives regarding the management of the environment.

Our actions are coupled with your environmental process

Reducing the impact on industrial sites

Parker Legris has integrated environmental protection management into the operation of its industrial sites. This approach has enabled 85% of waste to be recovered and has reduced energy consumption by 15%.

Offering ecologically responsible products

Under its continuous improvement process, Parker Legris has integrated ecological design as an input parameter to innovation and uses Life Cycle Assessment (LCA) to optimise the environmental impact of its products.

Providing information on the PEP (Product Environmental Profile)

This communication tool is common to all industries and professions and delivers a reliable and clear message for promoting ecological advances and incorporating this data within the LCA equipment.

Getting ahead of regulations

Parker Legris goes beyond its statutory obligations and endeavours to find a good match between choice of materials, limitation of hazardous substances, selection of recycling channels and industrial performance to encourage the recycling of products at end of life.

Using our technology reduces the environmental impact

LIQUIfit®

Tube-to-Tube Connector



Market Standard

Tube-to-Tube Connector

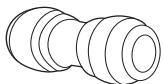

- Parker Legris
- Market Standard in PP
- Market Standard in POM

Stud Elbow

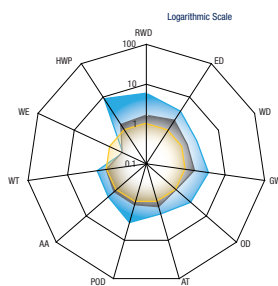

- RWD: Raw Material Depletion
- ED: Energy Depletion
- WD: Water Depletion
- GW: Global Warming

Tube-to-Tube Connector

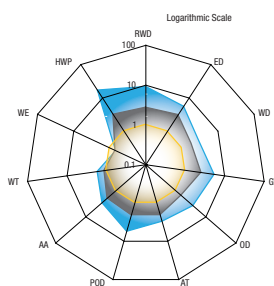

- OZ: Ozone Depletion
- AT: Air Toxicity
- POC: Photochemical Ozone Creation
- AA: Air Acidification

Stud Fitting

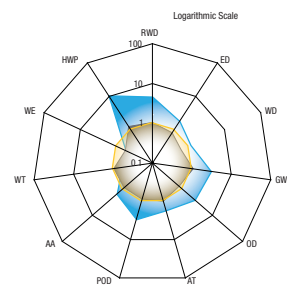

- WT: Water Toxicity
- WE: Water Eutrophication
- HWP: Hazardous Waste Production



Part Number Identification

The part numbers used for our product ranges are coded in such a way as to make it easy to identify any particular item.

Part Number Construction for Fittings and Valves

The part numbers are selected using a technical mnemonic code.

Each fitting and valve is identified by:

- model series (4 digits)
- nominal diameter (2 digits)
- thread or 2nd nominal diameter (2 digits)
- a suffix, if applicable

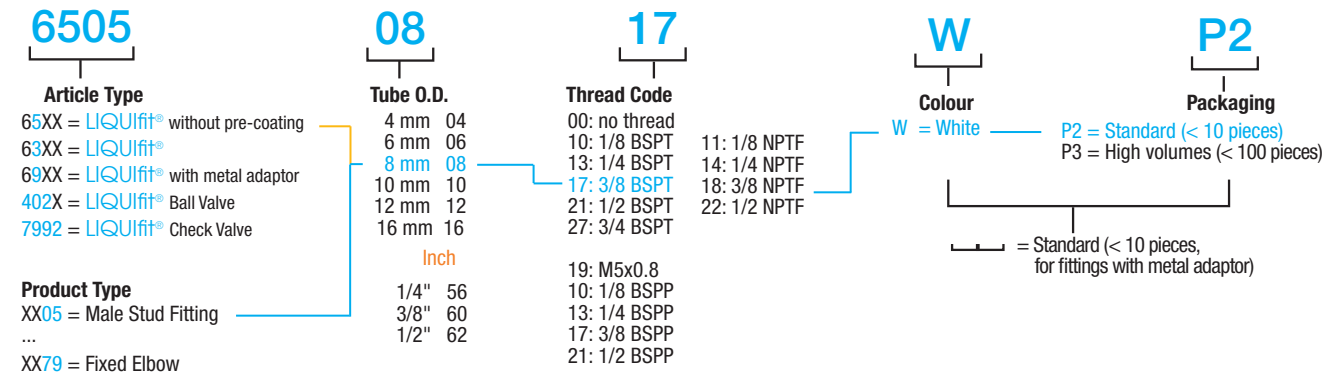

Part Number Construction for Tubing

The part numbers are selected using a technical mnemonic code.

Each tube is identified by:

- model series (4 digits and a letter)
- nominal diameter (2 digits)
- colour (2 digits)
- inside diameter, if applicable

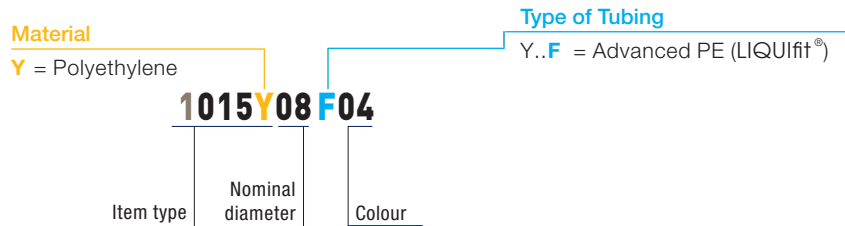

Nominal diameter code: equates to the outside diameter.

Colour code: see table below.

00 = (clear) 01 = 02 = 03 = 04 = 05 = 10 = (white)

Thread Identification

BSP Thread	Code
1/8"	10
1/4"	13
3/8"	17
1/2"	21
5/8"	23
3/4"	27

NPTF Thread	Code
1/8"	11
1/4"	14
3/8"	18
1/2"	22

Metric Thread	Code	UNS Thread	Code
M5x0.8	19	7/16-24	133

Product Ranges for Fluids and Beverages

Push-In Fittings

LIQUIfit® Push-In Fittings

[P. 12]



Fluids: water, beverages, coolants, inert gases

Materials: biopolymer, EPDM

Pressure: 16 bar

Temperature: -10°C to +120°C

Ø metric: 4 mm to 16 mm

Ø inch: 5/32" to 1/2"

Regulations: KTW, W270, FDA, NSF

LIQUIfit® Push-In Fittings with Metal Adaptors

[P.28]



Fluids:

Stainless steel 316L threads: water, beverages, industrial fluids

Nickel-plated brass threads: industrial fluids

Materials: biopolymer, EPDM, stainless steel 316L or FDA chemical nickel-plated brass

Pressure: 16 bar

Temperature: -10°C to +120°C

Ø metric: 4 mm to 16 mm

Regulations: KTW, W270, FDA

Tubing

Advanced PE Tubing

[P. 32]



Fluids: many fluids

Materials:

- 50% reticulated polyethylene, food-grade
- 6 colours

Pressure: 20 bar

Temperature: -40°C to +95°C

O.D. metric: 4 mm to 16 mm

O.D. inch: 1/4" to 1/2"

Regulations: KTW, W270, FDA, NSF

Crystal PU Tubing

[P. 34]



Fluids: compressed air and food industry fluids ("crystal")

Materials:

- Polyurethane food-grade "crystal"
- 7 colours

Pressure: 12 bar

Temperature: -20°C to +70°C

O.D. metric: 3 mm to 16 mm

O.D. inch: on request

Regulations: FDA, RG 1935/2004

FEP Tubing

[P. 36]



Fluids: many fluids

Materials:

- Fluoropolymer: fluorinated ethylene propylene, food-grade
- Transparent

Pressure: 28 bar

Temperature: -40°C to +150°C

O.D. metric: 4 mm to 12 mm

Regulations:

In standard: FDA

On special request: NSF, RG 1935/2004, EU 10/2011

Ball Valves and Non-Return Valves

LIQUIfit® Non-Return Valves

[P. 38]



Fluids: water, beverages, liquid foodstuffs

Materials: polymer for food applications

Pressure: 10 bar

Temperature: 0°C to +65°C

Ø metric: 6 mm to 12 mm

Ø inch: 1/4" to 1/2"

LIQUIfit® Ball Valves,

[P. 40]



Fluids: water, beverages, CO₂, inert gases

Materials: polypropylene, EPDM seal

Pressure: 10 bar

Temperature: -15°C to +100°C

Tube Ø: 1/4" and 3/8"

Range of LIQUIfit® Push-In Fittings



Stud Fittings

Straights					Straights - Inch				
6501 BSPP Page 14 <i>New</i>	6505 BSPT Page 14	6315 BSPT Page 14	6352 BSPP Page 15	6521 BSPT Page 16	6505 NPTF/BSPT Page 14	6315 NPTF Page 15	6352 BSPP Page 15	6325 UNS Page 15	6521 NPTF/BSPT Page 16
Elbows			Elbows - Inch		Tees		Tees - Inch		Plugs
6579 BSPT Page 17	6509 BSPT Page 17	6599 BSPP Page 17 <i>New</i>	6579 BSPT/NPTF Page 17	6509 BSPT/NPTF Page 18	6508 BSPT Page 18	6503 BSPT Page 19	6508 NPTF Page 18		6355 BSPT Page 18

Tube-to-Tube Fittings

Straight		Straight - Inch		Elbow		Elbow - Inch		Tee		Tee - Inch	
6306 Page 20		6306 Page 20		6302 Page 20		6302 Page 20		6304 Page 21		6304 Page 21	
Y		Y - Inch		Cross		Cross - Inch					
6340 Page 21		6340 Page 21		6307 Page 22		6307 Page 22					

Bulkhead Connectors

Straight		Straight - Inch
6316 Page 22	6976 Page 22	6316 Page 22

Plug-In Fittings and Accessories

Elbows			Elbow - Inch			Tees			Tee - Inch		
6382 Page 23	6380 Page 23	6382 Page 23	6382 Page 23	6380 Page 23	6382 Page 23	6383 Page 23	6388 Page 23	6388 Page 24	6388 Page 24	6388 Page 24	6388 Page 24

Accessories

Accessories					Accessories - Inch				
6366 Page 24	6326 Page 24	6322 Page 25	6351 Page 25	6986 Page 25	6366 Page 24	6368 Page 24	6326 Page 25	6322 Page 25	6351 Page 25

Polymer Cartridges for Fluids and Gases

Carstick®		Carstick® - Inch
6300 Page 26		6300 Page 26

Range of LIQUIfit® Push-In Fittings with Metal Adaptors



Stud Fittings with Stainless Steel Adaptor

Straight

Elbows

6911
Page 29

6975
Page 29

6959
Page 29

6974
Page 29

6979
Page 30



Stud Fittings with Nickel-Plated Brass Adaptor

Straight

Elbows

6901
Page 31

6905
Page 31

6999
Page 31

6909
Page 31

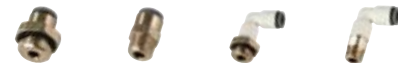

LIQUIfit® Accessories

3130
Page 27

3110
Page 27

0605
Page 27

3000 71 00
Page 27



Flexible Calibrated Tubing

Advanced PE

PU Ether Food-Grade "Crystal"

FEP



1015Y..F
1030Y..F
1075Y..F
1096Y..F
1098Y..F
1099Y..F
Page 33



1025U..R
1100U..R
2003U..R
2005U..R
2010U..R
Page 35



1005T
1025T
Page 37

LIQUIfit® Non-Return Valves

Non-Return Valves

7992
Page 39

7992
Inch
Page 39



LIQUIfit® Ball Valves

In-Line

Right-Angled

4020
2/2
Page 41

4021
2/2
Page 41

4023
2/2
Page 41

4022
2/2
Page 41



LIQUIfit® Push-In Fittings

This "eco-designed" range proposes an **innovative alternative** for water applications; **no fluid contamination** occurs and **environmental protection is guaranteed**. These fittings ensure **reliable and compact** connections for **liquid transfer** applications.

Product Advantages

Innovative Technology & Concept

- Ergonomic and aesthetic design
- The most compact product on the market for water, beverages and liquid foodstuffs
- Easy-to-clean external surfaces
- Push-in connection and disconnection
- Full flow
- Use with a pre-prepared metallic tubing
- Gripping system preventing any pumping effect
- Eco-designed (materials, manufacturing process, weight, dimensions and performance)

Optimal Performance

- Patented sealing technology
- 100% leak-tested in production
- Date coding to guarantee quality and traceability
- Wide range of shapes and numerous configurations

High Performance Material

- Bio-sourced polymer meeting the most severe food process regulations
- Suitable for contact with water and beverages
- Excellent chemical and mechanical resistance, even at high temperature
- Free of bisphenol A and phthalates, conforming with regulations



- Hot & Cold Drinks Dispensers
- Neutral Gases
- Cooling Systems
- Food Process
- Water Purification Systems
- Water Dispensers
- Medical

Applications

Technical Characteristics

Compatible Fluids	Water, beverages, CO ₂ (inert use) Chemical fluids: please consult us		
Working Pressure	Vacuum to 16 bar		
Working Temperature	-10°C to +120°C (up to 12 bar) for 4, 6 and 8 mm O.D. tube-to-tube fittings -10°C to +95°C for all other products		
Tightening Torques (BSPT/NPTF)	Thread	1/8" and 1/4"	3/8" and 1/2"
	daN.m	0.15	0.30

Reliable performance is dependent upon the type of fluid conveyed, component materials and tubing being used.
Use is guaranteed with a vacuum of 755 mm Hg (99% vacuum).

Component Materials

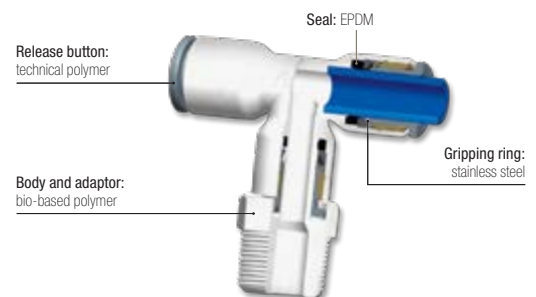

Silicone-free

Regulations

- DI: 2002/95/EC (RoHS), 2011/65/EC
- RG: 1935/2004/EC
- FDA: 21 CFR
- NSF 51 at 95°C
- NSF/ANSI 61 - C HOT

- DM 174
- WRAS
- ACS
- RG: 1907/2006 (REACH)
- KTW
- W270

Pressure and Temperature of the Different Diameters and Related Products of the LIQUIfit® Range

-10°C		Pressure (bar)	
mm Ø	inch Ø	Fittings	PE Tubing
4	5/32	16	16
6	1/4	16	16
8	5/16	16	16
10	3/8	13	15
12	1/2	11	11
16	5/8	10	9

+1°C		Pressure (bar)	
mm Ø	inch Ø	Fittings	PE Tubing
4	5/32	16	16
6	1/4	16	16
8	5/16	16	16
10	3/8	13	15
12	1/2	11	11
16	5/8	10	9

+20°C		Pressure (bar)	
mm Ø	inch Ø	Fittings	PE Tubing
4	5/32	16	16
6	1/4	16	16
8	5/16	16	16
10	3/8	13	15
12	1/2	11	11
16	5/8	10	9

+40°C		Pressure (bar)	
mm Ø	inch Ø	Fittings	PE Tubing
4	5/32	16	16
6	1/4	16	16
8	5/16	16	16
10	3/8	13	15
12	1/2	11	11
16	5/8	10	8

+65°C		Pressure (bar)	
mm Ø	inch Ø	Fittings	PE Tubing
4	5/32	12	10
6	1/4	12	10
8	5/16	12	10
10	3/8	7	7
12	1/2	7	7
16	5/8	10	6

+95°C		Pressure (bar)	
mm Ø	inch Ø	Fittings	PE Tubing
4	5/32	12	4
6	1/4	12	4
8	5/16	12	4
10	3/8	4	4
12	1/2	4	4

Environmental Footprint

Example: representation of the environmental footprint of an equal tube-to-tube connector

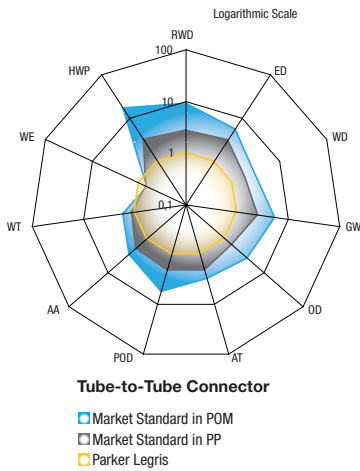

RWD: Raw Material Depletion
ED: Energy Depletion
WD: Water Depletion
GW: Global Warming
OZ: Ozone Depletion
AT: Air Toxicity

POC: Photochemical Ozone Creation
AA: Air Acidification
WT: Water Toxicity
WE: Water Eutrophication
HWP: Hazardous Waste Production

Environmental Approach

The Life Cycle Analysis (LCA) offers a true alternative in terms of environmental differentiation.

We carried out a comparative LCA on the market of drinking water between 3 Parker Legris fittings and the standard products on the market.

This analysis relies on ISO 14020, ISO 14025 and IEC PAS 62545 standards and the results are presented in a report approved by an ethics committee (Bureau Veritas).



Sealing Profile for Female Thread Stud Fitting

Stud Fitting,
Female NPTF Thread
6315

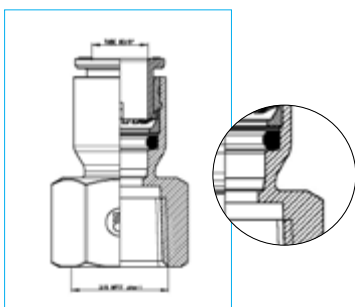

Stud Fitting Flat Type,
Female BSPP Thread,
6352 and 6333

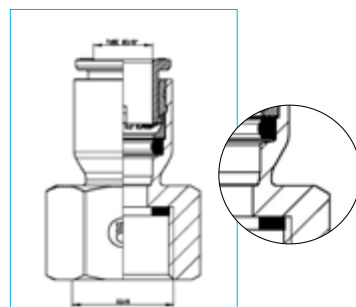

Stud Fittings

6501 Stud Fitting, Male BSPP Thread



POM, EPDM

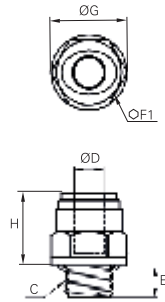

ØD	C		E	F	G	H	kg
6	G1/8	6501 06 10WP2	6	15	18	18	0.003
	G1/4	6501 06 13WP2	8.5	18	18	15.5	0.004
8	G1/8	6501 08 10WP2	6	17	18	18.5	0.005
	G1/4	6501 08 13WP2	8.5	18	18	20	0.006
10	G3/8	6501 08 17WP2	6	21	20	17.5	0.007
	G1/4	6501 10 13WP2	8.5	19	20	22	0.007
	G3/8	6501 10 17WP2	9	21	20	17	0.007
12	G1/2	6501 10 21WP2	12.5	26	21.5	17	0.011
	G3/8	6501 12 17WP2	9	24	21.5	25	0.011
	G1/2	6501 12 21WP2	12.5	26	21.5	20	0.012

These part numbers are also available on request in WP3 = high volumes (number of parts per bag: 40, 50 or 100, depending on the diameters).
Thread without pre-coating.

6505 Stud Fitting, Male BSPT Thread



Bio-based polymer, EPDM

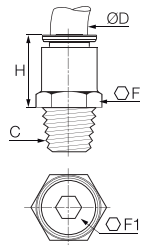

ØD	C		F	F1	H	kg
4	R1/8	6505 04 10WP2	11	3	18	0.003
	R1/4	6505 04 13WP2	14	3	18	0.004
6	R1/8	6505 06 10WP2	11	4	18	0.002
	R1/4	6505 06 13WP2	14	4	18	0.004
8	R1/8	6505 08 10WP2	17	6	20	0.004
	R1/4	6505 08 13WP2	14	6	20	0.004
	R3/8	6505 08 17WP2	17	6	20	0.005
10	R1/4	6505 10 13WP2	17	7	21.5	0.005
	R3/8	6505 10 17WP2	19	7	21.5	0.007
12	R1/2	6505 10 21WP2	22	7	21.5	0.010
	R3/8	6505 12 17WP2	19	9	24.5	0.008
	R1/2	6505 12 21WP2	22	9	24.5	0.012

These part numbers are also available on request in WP3 = high volumes (number of parts per bag: 40, 50 or 100, depending on the diameters).
Thread without pre-coating.

6505 Stud Fitting, Male NPTF Thread



Inch

Bio-based polymer, EPDM

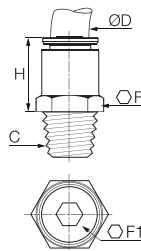

ØD	C		F	F1	H	kg
1/4	NPT1/8	6505 56 11WP2	1/2	5/32	17	0.002
	NPT1/4	6505 56 14WP2	9/16	5/32	17	0.003
	NPT3/8	6505 56 18WP2	3/4	1/4	21.5	0.004
3/8	NPT1/8	6505 60 11WP2	3/4	5/32	22.1	0.005
	NPT1/4	6505 60 14WP2	3/4	1/4	22	0.006
	NPT3/8	6505 60 18WP2	3/4	1/4	22	0.007
1/2	NPT1/2	6505 60 22WP2	15/16	1/4	27	0.012
	NPT3/8	6505 62 18WP2	15/16	3/8	28	0.012
	NPT1/2	6505 62 22WP2	15/16	3/8	28	0.013

These part numbers are also available on request in WP3 = high volumes (number of parts per bag: 40, 50 or 100, depending on the diameters).
Thread without pre-coating.

6505 Stud Fitting, Male BSPT Thread



Inch

Bio-based polymer, EPDM

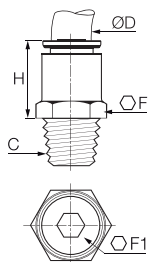

ØD	C		F	F1	H	kg
1/4	R1/8	6505 56 10WP2	11	5	17	0.002
	R1/4	6505 56 13WP2	14	5	17	0.003
3/8	R3/8	6505 60 17WP2	19	7	22	0.006
	R1/2	6505 60 21WP2	22	7	28	0.012
1/2	R1/2	6505 62 21WP2	24	9	28	0.017

These part numbers are also available on request in WP3 = high volumes (number of parts per bag: 40, 50 or 100, depending on the diameters).
5/32" (4 mm) and 5/16" (8 mm) also available.
Thread without pre-coating.

Working Temperature: up to +95°C

Stud Fittings

6315 Stud Connector, Female BSPT Thread



Bio-based polymer, EPDM

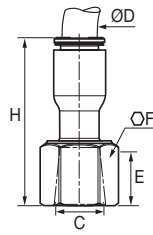

	ØD	C		E	F	H	kg
6	R1/8	6315 06 10WP2		11	13	32	0.003
	R1/4	6315 06 13WP2		14	16	33	0.004
8	R1/4	6315 08 13WP2		14	16	33.5	0.004
	R3/8	6315 08 17WP2		14	20	36	0.009

These part numbers are also available on request in WP3 = high volumes (number of parts per bag: 40, 50 or 100, depending on the diameters).

6315 Stud Fitting, Female NPTF Thread



Inch

Bio-based polymer, EPDM

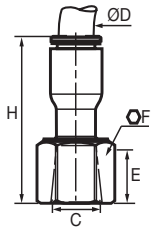

	ØD	C		F	H	kg
1/4	NPT1/4	6315 56 14WP2		11/16	30	0.003
3/8	NPT3/8	6315 60 18WP2		13/16	36	0.007

6352 Stud Fitting Flat Type, Female BSPP Thread



Bio-based polymer, EPDM

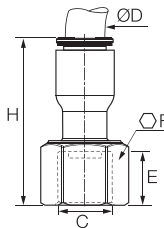

	ØD	C		E	F	H	kg
6	G3/4	6352 06 27WP2		11,5	32	32	0.011
8	G3/4	6352 08 27WP2		11,5	32	40,5	0.017
10	G1/2	6352 10 21WP2		10,5	27	36	0.011

6352 Stud Fitting Flat Type, Female BSPP Thread



Inch

Bio-based polymer, EPDM

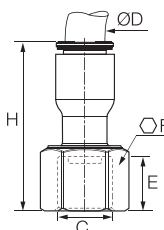

	ØD	C		E	F	H	kg
1/4	G3/4	6352 56 27WP2		11.5	32	31	0.006
	G3/8	6352 60 17WP2		12	22	36	0.008
3/8	G1/2	6352 60 21WP2		10.5	27	36	0.011
	G3/4	6352 60 27WP2		11.5	32	41	0.018
1/2	G5/8	6352 62 23WP2		10.5	29	35.5	0.013
	G3/4	6352 62 27WP2		11.5	32	44.5	0.014

6325 Faucet Connector, Female UNS Thread



Inch

Bio-based polymer, EPDM

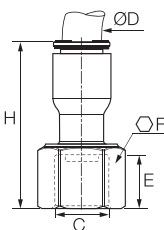

	ØD	C		E	F	H	kg
1/4	UNS7/16-24	6325 56 133WP2		7	9/16	31	0.002

Working Temperature: up to +95°C

Stud Fittings

6521 Stud Standpipe, Male BSPT Thread



Bio-based polymer

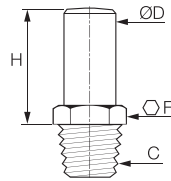

ØD	C		F	H	kg
6	R1/8	6521 06 10WP2	13	19	0.002
	R1/4	6521 06 13WP2	14	19	0.003
	R3/8	6521 06 17WP2	17	19	0.004
8	R1/8	6521 08 10WP2	19	23	0.003
	R1/4	6521 08 13WP2	19	23	0.004
	R3/8	6521 08 17WP2	19	23	0.004
10	R1/4	6521 10 13WP2	19	25	0.004
	R3/8	6521 10 17WP2	19	25	0.005
	R1/2	6521 10 21WP2	22	25	0.008
12	R3/8	6521 12 17WP2	22	28	0.005
	R1/2	6521 12 21WP2	22	28	0.007

Thread without pre-coating.

6521 Stud Standpipe, Male NPTF Thread



Inch

Bio-based polymer

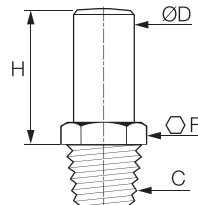

ØD	C		F	H	kg
1/4	NPT1/8	6521 56 11WP2	1/2	19	0.001
	NPT3/8	6521 56 18WP2	3/4	19.5	0.004
3/8	NPT1/4	6521 60 14WP2	3/4	25	0.004
	NPT3/8	6521 60 18WP2	3/4	25	0.004
1/2	NPT1/2	6521 62 22WP2	15/16	32.5	0.013

Thread without pre-coating.

6521 Stud Standpipe, Male BSPT Thread



Inch

Bio-based polymer

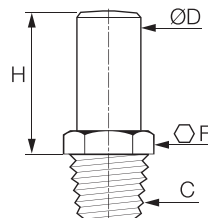

ØD	C		F	H	kg
1/4	R1/4	6521 56 13WP2	14	19	0.002
	R3/8	6521 56 17WP2	17	19	0.004
3/8	R3/8	6521 60 17WP2	19	25	0.004

Thread without pre-coating. 5/16" (8mm) also available.

Working Temperature: up to +95°C

Stud Fittings

6579 Fixed Elbow, Male BSPT Thread



Bio-based polymer, EPDM

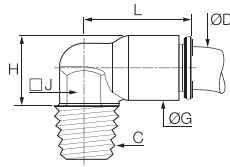

ØD	C		G	H	J	L	kg
6	R1/8	6579 06 10WP2	11	14	10	19	0.002
	R1/4	6579 06 13WP2	11	14	10	19	0.003
	R3/8	6579 06 17WP2	11	14	10	19	0.004

Thread without pre-coating.

6579 Fixed Elbow, Male NPTF Thread



Inch

Bio-based polymer, EPDM

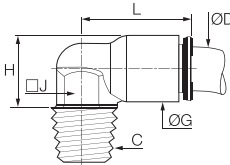

ØD	C		G	H	J	L	kg
1/4	NPT1/8	6579 56 11WP2	11	22	3/8	18	0.009
	NPT1/4	6579 56 14WP2	11	26	3/8	18	0.003
3/8	NPT1/4	6579 60 14WP2	16	32	1/2	26	0.006
	NPT3/8	6579 60 18WP2	16	32	1/2	26	0.006

Thread without pre-coating.

6579 Fixed Elbow, Male BSPT Thread



Inch

Bio-based polymer, EPDM

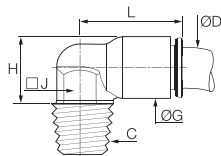

ØD	C		G	H	J	L	kg
1/4	R1/4	6579 56 13WP2	11	26	10	18	0.003
	R3/8	6579 56 17WP2	11	26	10	18	0.004
3/8	R1/4	6579 60 13WP2	16	31.5	13	26	0.006
	R3/8	6579 60 17WP2	16	32	13	26	0.006

Thread without pre-coating.

6599 Stud Elbow, Male BSPP Thread

POM, EPDM

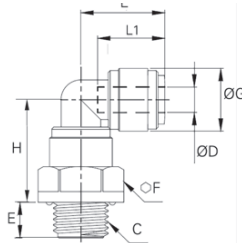

ØD	C		E	F	G	H	L	L1	kg
6	G1/8	6599 06 10WP2	6	17	15	24.5	20	16	0.007
	G1/4	6599 06 13WP2	8.5	18	15	33	20		0.008
	G1/8	6599 08 10WP2	6	18	17.5	26	22		0.010
8	G1/4	6599 08 13WP2	8.5	18	17.5	26	22	17.5	0.011
	G3/8	6599 08 17WP2	9	22	17.5	26	22	17.65	0.012
	G1/4	6599 10 13WP2	8.5	22	20	29.5	26	20	0.015
10	G3/8	6599 10 17WP2	9	22	20	29.5	26	20	0.015
	G1/2	6599 10 21WP2	12.5	26	20	29.5	26	20	0.019
	G3/8	6599 12 17WP2	9	26	23	34.5	31.5	24.5	0.023
12	G1/2	6599 12 21WP2	12.5	26	23	34.5	31.5	14.5	0.025

These part numbers are also available on request in WP3 = high volumes (number of parts per bag: 40, 50 or 100, depending on the diameters). Thread without pre-coating; the body swivels for positioning purposes.

6509 Stud Elbow, Male BSPT Thread



Bio-based polymer, EPDM

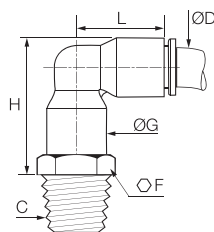

ØD	C		F	G	H	L	kg
6	R1/8	6509 06 10WP2	13	10.5	28	24	0.037
	R1/4	6509 06 13WP2	14	10.5	28	24	0.007
	R3/8	6509 06 17WP2	17	10.5	28	24	0.008
8	R1/8	6509 08 10WP2	19	13.5	34	29.5	0.010
	R1/4	6509 08 13WP2	19	13.5	34	29.5	0.011
	R3/8	6509 08 17WP2	19	13.5	34	29.5	0.011
10	R1/4	6509 10 13WP2	19	16	38	34.5	0.019
	R3/8	6509 10 17WP2	19	16	38	34.5	0.020
	R1/2	6509 10 21WP2	22	16	38	34.5	0.023
12	R3/8	6509 12 17WP2	22	19	44	40	0.022
	R1/2	6509 12 21WP2	22	19	44	40	0.024

These part numbers are also available on request in WP3 = high volumes (number of parts per bag: 40, 50 or 100, depending on the diameters). Thread without pre-coating; the body swivels for positioning purposes.

Working Temperature: up to +95°C

Stud Fittings

6509 Stud Elbow, Male NPTF Thread



Bio-based polymer, EPDM

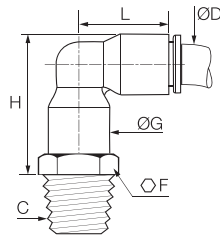

ØD	C		F	G	H	L	kg
1/4	NPT1/8	6509 56 11WP2	1/2	11	28	23.5	0.003
	NPT1/4	6509 56 14WP2	9/16	11	28	23.5	0.004
3/8	NPT3/8	6509 56 18WP2	3/4	11	28.5	23.5	0.006
	NPT1/4	6509 60 14WP2	3/4	16	38	34	0.010
	NPT3/8	6509 60 18WP2	3/4	16	38	34	0.011

Thread without pre-coating, the body swivels for positioning purposes.

6509 Stud Elbow, Male BSPT Thread



Bio-based polymer, EPDM

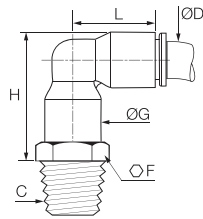

ØD	C		F	G	H	L	kg
1/4	R1/4	6509 56 13WP2	14	11	28	23.5	0.004
1/2	R1/2	6509 62 21WP2	24	22	50.5	46.5	0.027

5/16" (8 mm) also available.

Thread without pre-coating, the body swivels for positioning purposes.

6508 Branch Tee, Male BSPT Thread



Bio-based polymer, EPDM

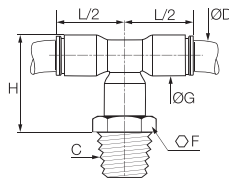

ØD	C		F	G	H	L/2	kg
6	R1/8	6508 06 10WP2	13	10.5	28	18	0.008
	R1/4	6508 06 13WP2	14	10.5	28	18	0.009
	R3/8	6508 06 17WP2	17	10.5	28	18	0.010
8	R1/8	6508 08 10WP2	19	13.5	34	23	0.012
	R1/4	6508 08 13WP2	19	13.5	34	23	0.013
10	R3/8	6508 08 17WP2	19	13.5	34	23	0.013
	R1/4	6508 10 13WP2	19	16	38	26.5	0.018
	R3/8	6508 10 17WP2	19	16	38	26.5	0.019
12	R1/2	6508 10 21WP2	22	16	38	26.5	0.022
	R3/8	6508 12 17WP2	22	19	44	31	0.024
	R1/2	6508 12 21WP2	22	19	44	31	0.026

Thread without pre-coating, the body swivels for positioning purposes.

6508 Branch Tee, Male NPTF Thread



Bio-based polymer, EPDM

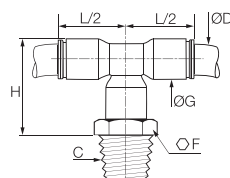

ØD	C		F	G	H	L/2	kg
1/4	NPT1/8	6508 56 11WP2	1/2	11	28	18	0.004
1/2	NPT1/2	6508 62 22WP2	15/16	22	51	35.5	0.034

Thread without pre-coating, the body swivels for positioning purposes.

Working Temperature: up to +95°C

Stud Fittings

6503 Run Tee, Male BSPT Thread



Bio-based polymer, EPDM

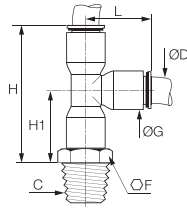

ØD	C		F	G	H	H1	L	kg
6	R1/4	6503 06 13WP2	14	10.5	40	22	18.5	0.009
	R1/8	6503 08 10WP2	19	13.5	50	27	23	0.012
8	R1/4	6503 08 13WP2	19	13.5	50	27	23	0.013
	R3/8	6503 08 17WP2	19	13.5	50	27	23	0.013
12	R3/8	6503 12 17WP2	22	19	65.5	34.5	31	0.024
	R1/2	6503 12 21WP2	22	19	65.5	34.5	31	0.026

Thread without pre-coating, the body swivels for positioning purposes.

6355 Unequal Connector, Female BSPP Thread



Bio-based polymer

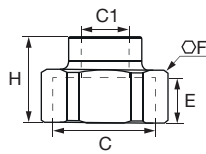

C	C1		E	F	H	kg
G3/4	G1/4	6355 13 27WP2	10	32	23.5	0.050

Working Temperature: up to +95°C

Tube-to-Tube Fittings

6306 Equal and Unequal Tube-to-Tube Connector



Bio-based polymer, EPDM

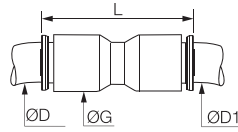

ØD	ØD1		G	L	kg
4	4	6306 04 00WP2	8.5	26.5	0.002
	6	6306 04 06WP2	10.5	29	0.002
	8	6306 04 08WP2	13.5	37	0.005
6	6	6306 06 00WP2	10.5	30	0.004
	8	6306 06 08WP2	13.5	37	0.005
	10	6306 06 10WP2	16	42	0.007
8	8	6306 08 00WP2	13.5	37	0.004
	10	6306 08 10WP2	16	42	0.007
	12	6306 08 12WP2	19	50	0.012
10	10	6306 10 00WP2	16	42	0.009
	12	6306 10 12WP2	19	50	0.013
12	12	6306 12 00WP2	19	50.5	0.009
	16	6306 16 00 New	27	60.5	0.023

These part numbers are also available on request in WP3 = high volumes (number of parts per bag: 40, 50 or 100, depending on the diameters).

6306 Equal and Unequal Tube-to-Tube Connector



Inch

Bio-based polymer, EPDM

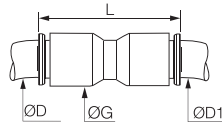

ØD	ØD1		G	L	kg
5/16	3/8	6306 08 60WP2	16	42	0.008
	1/2	6306 08 62WP2	22	55	0.018
1/4	1/4	6306 56 00WP2	11	30	0.002
	3/8	6306 56 60WP2	16	41	0.007
3/8	3/8	6306 60 00WP2	16	42	0.006
	1/2	6306 60 62WP2	22	56	0.020
1/2	1/2	6306 62 00WP2	22	57	0.016

These part numbers are also available on request in WP3 = high volumes (number of parts per bag: 40, 50 or 100, depending on the diameters).

6302 Equal and Unequal Elbow



Bio-based polymer, EPDM

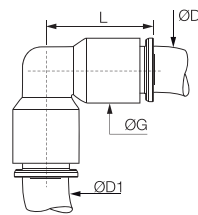

ØD	ØD1		G	L	kg
4	4	6302 04 00WP2	8.5	19	0.002
	6	6302 04 06WP2	10.5	24	0.004
6	6	6302 06 00WP2	10.5	24	0.004
	8	6302 06 08WP2	13.5	29.5	0.006
8	8	6302 08 00WP2	13.5	29	0.004
	10	6302 08 10WP2	16	34.5	0.008
10	10	6302 10 00WP2	16	34.5	0.005
	12	6302 10 12WP2	19	40.5	0.013
12	12	6302 12 00WP2	19	40.5	0.010
	16	6302 16 00 New	27	53	0.024

These part numbers are also available on request in WP3 = high volumes (number of parts per bag: 40, 50 or 100, depending on the diameters).

6302 Equal and Unequal Elbow



Inch

Bio-based polymer, EPDM

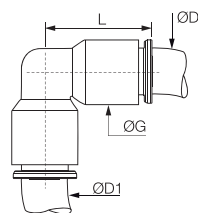

ØD	ØD1		G	L	kg
5/16	3/8	6302 08 60WP2	16	34	0.009
	1/4	6302 56 00WP2	11	24	0.005
1/4	5/16	6302 56 08WP2	13.5	29.5	0.006
	3/8	6302 56 60WP2	16	34	0.008
3/8	3/8	6302 60 00WP2	16	34	0.006
	1/2	6302 60 62WP2	22	46.5	0.011
1/2	1/2	6302 62 00WP2	22	46.5	0.017

These part numbers are also available on request in WP3 = high volumes (number of parts per bag: 40, 50 or 100, depending on the diameters).

Working Temperature: -10°C to +120°C for O.D. 4, 6 and 8 mm
-10°C to +95°C for all other diameters

Tube-to-Tube Fittings

6304 Equal Tee



Bio-based polymer, EPDM

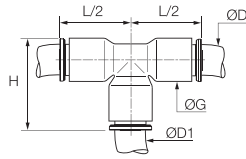

ØD	ØD1		G	H	L/2	kg
4	4	6304 04 00WP2	8.5	20	15.5	0.004
6	6	6304 06 00WP2	10.5	23	18	0.006
8	8	6304 08 00WP2	13.5	29	22.5	0.006
10	10	6304 10 00WP2	16	34.5	26.5	0.009
12	12	6304 12 00WP2	19	40	31	0.014
16	16	6304 16 00 <i>New</i>	27	53	39	0.063
16	12	6304 16 12 <i>New</i>	27	53	39	0.037

These part numbers are also available on request in WP3 = high volumes (number of parts per bag: 40, 50 or 100, depending on the diameters).

6304 Equal and Unequal Tee



Inch

Bio-based polymer, EPDM

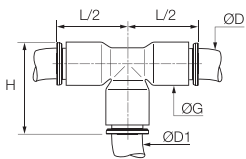

ØD	ØD1		G	H	L/2	kg
1/4	1/4	6304 56 00WP2	11	24	18	0.002
3/8	3/8	6304 60 00WP2	16	34	26	0.009
	1/4	6304 60 56WP2	16	34	26	0.011
1/2	1/2	6304 62 00WP2	22	47	36	0.027
	3/8	6304 62 60WP2	22	47	36	0.009

These part numbers are also available on request in WP3 = high volumes (number of parts per bag: 40, 50 or 100, depending on the diameters).
5/32" (4 mm) and 5/16" (8 mm) also available.

6340 Equal Single Y Piece



Bio-based polymer, EPDM

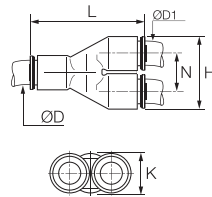

ØD	ØD1		H	K	L	N	kg
4	4	6340 04 00WP2	17.5	8.5	30	9	0.004
6	6	6340 06 00WP2	21.5	10.5	36.5	11	0.008
8	8	6340 08 00WP2	28	13.5	44.5	14.5	0.007
10	10	6340 10 00WP2	33	16	53	17	0.010
12	12	6340 12 00WP2	39	19	60.5	20	0.025

These part numbers are also available on request in WP3 = high volumes (number of parts per bag: 40, 50 or 100, depending on the diameters).

6340 Equal Single Y Piece



Inch

Bio-based polymer, EPDM

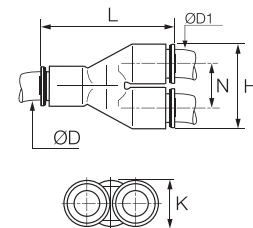

ØD	ØD1		H	K	L	N	kg
1/4	1/4	6340 56 00WP2	22	11	36	11.5	0.010
3/8	3/8	6340 60 00WP2	33	16	53	17	0.011
1/2	1/2	6340 62 00WP2	45	22	67	23	0.028

These part numbers are also available on request in WP3 = high volumes (number of parts per bag: 40, 50 or 100, depending on the diameters).
5/32" (4 mm) and 5/16" (8 mm) also available.

Working Temperature: -10°C to +120°C for O.D. 4, 6 and 8 mm
-10°C to +95°C for all other diameters

Tube-to-Tube and Bulkhead Connectors

6307 Equal Cross



Bio-based polymer, EPDM

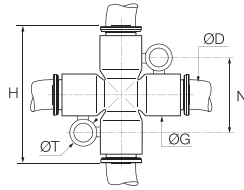

ØD		G	H	N	ØT	kg
6	6307 06 00WP2	11	36	20	4.2	0.005
8	6307 08 00WP2	13.5	45	22.5	4.2	0.020

6307 Equal Cross



Bio-based polymer, EPDM

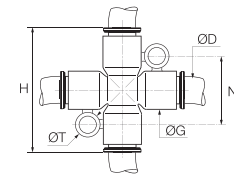

ØD		G	H	L	ØT	kg
1/4	6307 56 00WP2	11	36	20	4.2	0.010

5/16" (8 mm) also available

6316 Equal Bulkhead Union



Bio-based polymer, EPDM

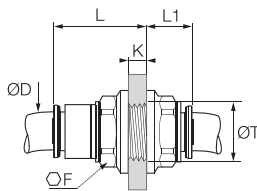

ØD			F	K _{max}	L	L1	ØT _{min}	kg
4	6316 04 00WP2		13	5.5	15.5	10.5	10.5	0.018
6	6316 06 00WP2	6316 06 00WP3	15	8.5	20	10	12.5	0.004
8	6316 08 00WP2	6316 08 00WP3	18	14.5	27	10.5	15.5	0.007
10	6316 10 00WP2	6316 10 00WP3	22	14.5	30	13	18.5	0.012
12	6316 12 00WP2	6316 12 00WP3	26	18.5	35	15.5	22.5	0.020

WP3 = high volumes (number of parts per bag: 40, 50 or 100, depending on the diameters)

6316 Equal Bulkhead Union



Inch

Bio-based polymer, EPDM

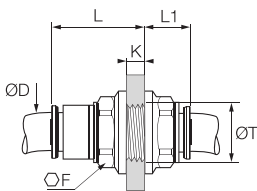

ØD			F	K _{max}	L	L1	ØT _{min}	kg
1/4	6316 56 00WP2	6316 56 00WP3	15	8.5	20	10	12.5	0.004
3/8	6316 60 00WP2		22	14.5	29.5	12.5	18.5	0.012
1/2	6316 62 00WP2		29	20.5	40.5	17	25.5	0.030

WP3 = high volumes (number of parts per bag: 40, 50 or 100, depending on the diameters)
5/32" (4 mm) and 5/16" (8 mm) also available

6976 Bulkhead Union



Acier inox 316L, EPDM

Stainless steel 316L, EPDM

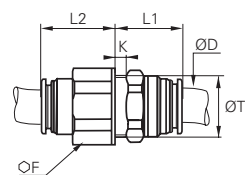

ØD		F	K _{max}	L1	L2	ØT _{min}	kg
16	6976 16 00	32	10.5	33	30	27.5	0.166

Electrical protection class IP55

Working Temperature: -10°C to +120°C for O.D. 4, 6 and 8 mm
-10°C to +95°C for all other diameters

Plug-In Fittings

6382 Equal and Unequal Plug-In Elbow



Bio-based polymer, EPDM

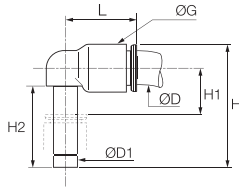

ØD	ØD1			G	H	H1	H2	L	kg
4	4	6382 04 00WP2*		8.5	23	6	15.5	15	0.003
	6	6382 04 06WP2		10.5	26.5	7	17	16.5	0.002
6	6	6382 06 00WP2	6382 06 00WP3	10.5	26.5	7	17	17	0.003
	4	6382 06 04WP2		10.5	25	7	15.5	17	0.001
8	8	6382 06 08WP2		13.5	33.5	8	21.5	22.5	0.004
	8	6382 08 00WP2	6382 08 00WP3	13.5	33.5	8	21.5	22.5	0.004
10	10	6382 08 10WP2		16	39	9.5	24.5	26	0.007
	10	6382 10 00WP2		16	39	9.5	24.5	26.5	0.004
12	12	6382 10 12WP2*		19	44.5	10	27	30	0.011
	12	6382 12 00WP2*		19	44.5	10	27	31	0.012

WP3 = high volumes (number of parts per bag: 40, 50 or 100, depending on the diameters).
* Diameters 4 mm and 12 mm are not grooved in standard version.

6382 Equal and Unequal Plug-In Elbow



Inch

Bio-based polymer, EPDM

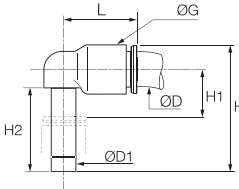

ØD	ØD1			G	H	H1	H2	L	kg
5/16	3/8	6382 08 60WP2		16	39	10	24.5	26	0.009
1/4	1/4	6382 56 00WP2*	6382 56 00WP3	11	30.5	11	18	18	0.000
	3/8	6382 56 60WP2		16	39	9	24.5	25.5	0.006
3/8	3/8	6382 60 00WP2		16	39	9	24.5	26.5	0.005
1/2	1/2	6382 62 00WP2		22	49	13	28.5	36	0.000

WP3 = high volumes (number of parts per bag: 40, 50 or 100, depending on the diameters)
Equal plug-in elbow: 5/32" (4 mm) and 5/16" (8 mm) also available

6380 Plug-In 45° Equal Elbow



Bio-based polymer, EPDM

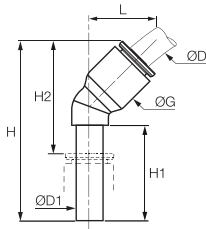

ØD	ØD1			G	H	H1	H2	L	kg
4	4	6380 04 00WP2		8.5	33.5	19	21	13	0.001
6	6	6380 06 00WP2		11	39	21	25	14.5	0.002
8	8	6380 08 00WP2		13.5	44	21.5	25.5	19.5	0.006
10	10	6380 10 00WP2		16	53	27	32.5	23	0.004
12	12	6380 12 00WP2		19	58	27	34	26	0.012

For rotary applications, we recommend the use of a special grooved version, available upon request.

6383 Plug-In Equal Run Tee



Bio-based polymer, EPDM

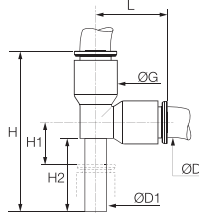

ØD	ØD1			G	H	H1	H2	L	kg
4	4	6383 04 00WP2		8.5	33	6	15.5	15	0.002
6	6	6383 06 00WP2		10.5	38.5	7	17	18	0.002
8	8	6383 08 00WP2	6383 08 00WP3	13.5	49	8	21.5	23	0.005
10	10	6383 10 00WP2		16	57	10.5	25.5	26.5	0.012

WP3 = high volumes (number of parts per bag: 40, 50 or 100, depending on the diameters)
For rotary applications, we recommend the use of a special grooved version, available upon request.

6388 Plug-In Equal Branch Tee



Bio-based polymer, EPDM

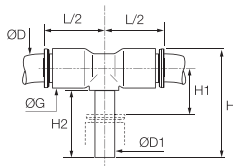

ØD	ØD1			G	H	H1	H2	L/2	kg
4	4	6388 04 00WP2		8.5	25	6	15.5	15	0.005
6	6	6388 06 00WP2		10.5	28.5	7	17	16	0.006
8	8	6388 08 00WP2		13.5	33.5	8	21.5	23	0.005
10	10	6388 10 00WP2		16	41	9.5	24.5	26.5	0.007

For rotary applications, we recommend the use of a special grooved version, available upon request.

Working Temperature: -10°C to +120°C for O.D. 4, 6 and 8 mm
-10°C to +95°C for all other diameters

Plug-In Fittings and Accessories

6388 Plug-In Branch Tee



Bio-based polymer, EPDM

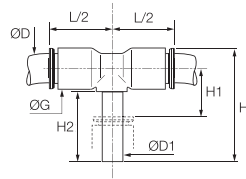

ØD	ØD1		G	H	H1	H2	L/2	kg
1/4	1/4	6388 56 00WP2	11	30.5	11	20	18	0.002
3/8	3/8	6388 60 00WP2	16	42	12	25	25	0.008

5/32" (4 mm) and 5/16" (8 mm) also available

For rotary applications, we recommend the use of a special grooved version, available upon request.

6366 Plug-In Reducer



Bio-based polymer, EPDM

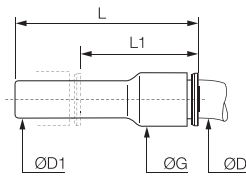

ØD	ØD1		G	L	L1	kg
4	6	6366 04 06WP2	8.5	38	23.5	0.004
	8	6366 04 08WP2	8.5	38	19	0.004
6	8	6366 06 08WP2	10.5	38	20	0.004
	10	6366 06 10WP2	10.5	39	17.5	0.002
8	10	6366 08 10WP2	13.5	48.5	28.5	0.009
	12	6366 08 12WP2	13.5	48.5	24.5	0.004
10	12	6366 10 12WP2	16	52	33.5	0.005
	14	6366 10 14WP2	16	53	33.5	0.005

These part numbers are also available on request in WP3 = high volumes (number of parts per bag: 40, 50 or 100, depending on the diameters). Thread without pre-coating; the body swivels for positioning purposes.

For rotary applications, we recommend the use of a special grooved version, available upon request.

6366 Plug-In Reducer



Bio-based polymer, EPDM

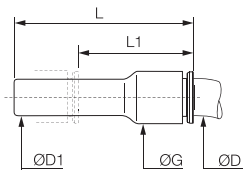

ØD	ØD1		G	L	L1	kg
1/4	5/16	6366 56 08WP2	11	41	22.5	0.015
	3/8	6366 56 60WP2	11	41	20.5	0.002
5/16	3/8	6366 08 60WP2	13.5	48.5	29	0.003
	1/2	6366 08 62WP2	16	48.5	22	0.007
3/8	1/2	6366 60 62WP2	16	51	30	0.011

5/32" (4 mm) and 5/16" (8 mm) also available

For rotary applications, we recommend the use of a special grooved version, available upon request.

6368 Plug-In Increaser



Bio-based polymer, EPDM

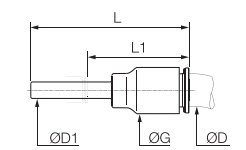

ØD	ØD1		G	L	L1	kg
3/8	5/16	6368 60 08WP2	16	44	25.5	0.004

For rotary applications, we recommend the use of a special grooved version, available upon request.

6326 Blanking Plug



Bio-based polymer

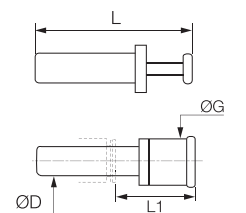

ØD		G	L	L1	kg
4	6326 04 00WP2	6	30	15.5	0.001
6	6326 06 00WP2	8	33	16.5	0.001
8	6326 08 00WP2	10	35	17.5	0.002
10	6326 10 00WP2	12	42	21	0.003
12	6326 12 00WP2	14	45	22	0.004

These part numbers are also available on request in WP3 = high volumes (number of parts per bag: 40, 50 or 100, depending on the diameters).

Working Temperature: -10°C to +120°C for O.D. 4, 6 and 8 mm
-10°C to +95°C for all other diameters

Accessories

6326 Blanking Plug



Bio-based polymer

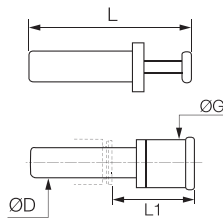

ØD			G	L	L1	kg
1/4			8	36.5	22	0.001
3/8			11.6	42.5	22	0.002
1/2			14.7	48.5	21.5	0.004

WP3 = high volumes (number of parts per bag: 40, 50 or 100, depending on the diameters)
5/32" (4 mm) and 5/16" (8 mm) also available

6322 Plug-In Barb Connector



Bio-based polymer

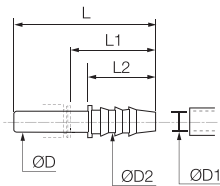

ØD	ØD1	ØD2		L	L1	L2	kg
6	4	96		39	25	17	0.004
8	6	7.75		43	25	17	0.005
10	7	9		50	29.5	22	0.006
12	12.5	15.5		56	32	27.5	0.004

6322 Plug-In Barb Connector



Bio-based polymer

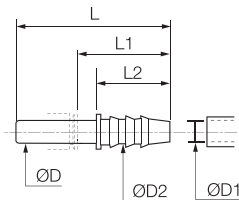

ØD	ØD1	ØD2		L	L1	L2	kg
1/4	0.28	0.32		39	24.5	17	0.001
	0.33	0.38		50	29.5	22	0.001
3/8	0.28	0.32		45	24.5	17	0.008
	0.40	0.45		50	29	22	0.002
1/2	0.40	0.45		58	37.5	30	0.005

6986 Blanking Plug



Stainless steel 316L

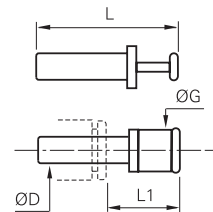

ØD	ØD1	ØD2		E	L	L1	kg
16	0.28	0.32		18	57	35	0.060

These part numbers are also available on request in WP3 = high volumes (number of parts per bag: 40, 50 or 100, depending on the diameters).

Up to +150°C

6351 End Cap



Bio-based polymer, EPDM

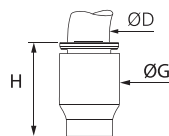

ØD			G	H	kg
4			8.5	15	0.001
6			10.5	17	0.002
8			13.5	21.5	0.003
10			16	22	0.003
12			19	27.5	0.006

6351 End Cap



Bio-based polymer, EPDM

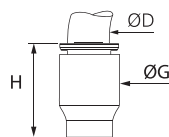

ØD			G	H	kg
1/4			11	16	0.001
3/8			16	22.5	0.003

5/32" (4 mm) and 5/16" (8 mm) also available

Working Temperature: -10°C to +120°C for O.D. 4, 6 and 8 mm
-10°C to +95°C for all other diameters

Polymer Cartridges for Fluids and Gases

6300

LIQUIfit® Cartridge, Up to +120°C



Brass, EPDM

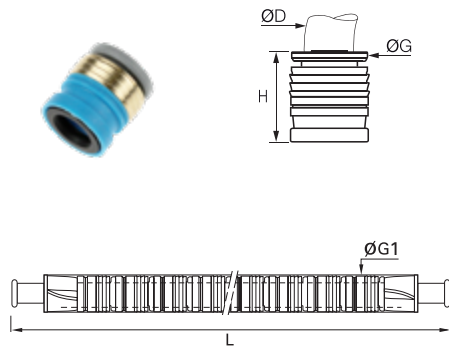

ØD		G	G1	H	L	kg
4	6300 04 00	8	11	10	554	0.002
6	6300 06 00	10	14.5	11.5	629	0.002
8	6300 08 00	13	15	15	794	0.003
10	6300 10 00	15.5	19.5	17	930	0.005
12	6300 12 00	18.5	21	19.5	1038	0.010

Inch

ØD		G	G1	H	L	kg
1/4	6300 56 00	10.5	14.5	12.5	600	0.002
3/8	6300 60 00	15.5	19	17	930	0.005
1/2	6300 62 00	22	25	23	1038	0.011

50 cartridges per Carstick®
5/32" (4 mm) and 5/16" (8 mm) also available

LIQUIfit® Cavity Dimensions

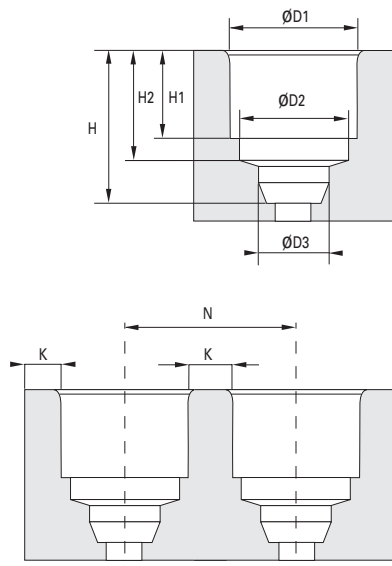

LIQUIfit® Carstick®

Metric

LIQUIfit® Carstick®

Inch

Cavity	ØD3	H	H1	H2
4	4.1	10	6	8.15
6	6.1	12	7.5	9.65
8	8.15	15.5	9.9	12.45
10	10.25	19	11.7	14.35
12	12.17	22	13.9	16.75

Cavity	ØD3	H	H1	H2
1/8	3.25	7.45	5.3	9.5
5/32*	4.1	8.15	6	10
1/4	6.45	10.15	8	12.5
5/16*	8.15	12.45	9.9	15.5
3/8	9.65	14.35	11.7	19

Polyamide Cavity

Cavity	ØD1	ØD2	N	K
4	8.25	7.05	9.8	1.5
6	10.2	9.15	12.2	2
8	12.15	10.85	14.2	2
10	14.8	13.2	16.8	2
12	17.5	15.5	20	2.5

Cavity	ØD1	ØD2	N	K
1/8	7.05	6.02	8.6	1.5
5/32*	8.25	7.05	9.75	1.5
1/4	10.55	9.35	12.6	2
5/16*	12.15	10.85	14.2	2
3/8	14.8	13.1	16.8	2

Aluminium Cavity

Cavity	ØD1	ØD2	N	K
4	8.25	7.5	11.5	3
6	10.3	9.15	13.5	3
8	12.2	10.85	15.2	3
10	15.05	13.2	17.1	2
12	17.5	15.5	20	2.5

Cavity	ØD1	ØD2	N	K
1/8	7.1	6.2	8.6	1.5
5/32*	8.25	7.05	11.25	3
1/4	10.6	9.35	12.65	2
5/16*	12.2	10.85	15.2	3
3/8	15.05	13.1	17.1	2

Brass Cavity

Cavity	ØD1	ØD2	N	K
4	8.25	7.05	10.25	2
6	10.25	9.1	12.25	2
8	12.2	10.85	14.25	2
10	15.05	13.2	17.1	2
12	17.65	15.5	20	2.5

Cavity	ØD1	ØD2	N	K
1/8	7.1	6.2	8.6	1.5
5/32*	8.25	7.05	10.25	2
1/4	10.6	9.35	12.65	2
5/16*	12.2	10.85	14.25	2
3/8	10.05	13.1	17.1	2

*5/32" = 4 mm and 5/16" = 8 mm

Please consult us for detailed drawings of cavity dimensions and tolerances.

All our dimensions are in millimeters.

High Temperature Carstick®:

Up to +150°C and 10 bar working pressure
FKM Seal, FDA certification
Available on demand for O.D. 4 mm and 6 mm



Accessories

3130 Tamper-Proof Safety Clip

Technical polymer

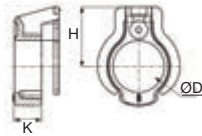

ØD							H	K	kg
4	3130 04 01	3130 04 02	3130 04 03	3130 04 04	3130 04 05		6.5	3	0.001
6	3130 06 01	3130 06 02	3130 06 03	3130 06 04	3130 06 05	3130 06 10	8	3	0.001
8	3130 08 01	3130 08 02	3130 08 03	3130 08 04	3130 08 05	3130 08 10	9.5	4.3	0.001
10	3130 10 01	3130 10 02	3130 10 03	3130 10 04	3130 10 05	3130 10 10	10.8	4.2	0.001
12	3130 12 01		3130 12 03	3130 12 04	3130 12 05	3130 12 10	12.5	5.1	0.003
14	3130 14 01		3130 14 03				12.5	5.1	0.004
16			3130 16 03						

3130 Tamper-Proof Safety Clip

Inch

Technical polymer

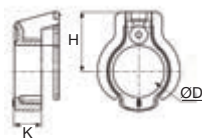

ØD					H	K	kg
1/4	3130 56 01	3130 56 03	3130 56 04	3130 56 10	8	3	0.001
3/8	3130 60 01	3130 60 03			11	4	0.001
1/2	3130 62 01	3130 62 03	3130 62 04		14	6	0.004

5/32" (4 mm) and 5/16" (8 mm) also available

3110 Coloured Release Button Covers

Technical polymer



ØD						kg
4	3110 04 00	3110 04 02	3110 04 03	3110 04 04	3110 04 05	0.006
6	3110 06 00	3110 06 02	3110 06 03	3110 06 04	3110 06 05	0.001
8	3110 08 00		3110 08 03	3110 08 04		0.001
10	3110 10 00			3110 10 04		0.001
12	3110 12 00					0.001
14	3110 12 00				3110 14 05	0.001

3110 Coloured Release Button Covers

Inch

Technical polymer



ØD				kg
1/4		3110 56 04		0.002
3/8	3110 60 00			0.001
1/2			3110 62 05	0.001

5/32" (4 mm) and 5/16" (8 mm) also available

0605 Fluoropolymer Tape

FKM



0605 12 12

kg

0.012

Can be used for temperatures from - 250°C to +260°C.

Chemically inert and resistant to gases, acids, solvents, hydrocarbons, oils, alkalines, steam etc.

Non-toxic, waterproof, self-lubricating.

In accordance with CFR21.

Can be used on all materials.

Used to facilitate the preparation of leak-free threaded joints.

Supplied on a reel, length = 12 m, width = 12.7 mm, thickness 0.08 mm.

3000 71 00 Tube Cutter

Technical polymer

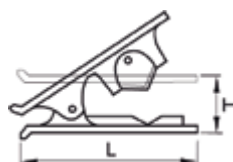

3000 71 00

H L kg

25 79 0.029

This tool is designed to give a clean cut at right angles to the tube axis for all resilient polymer tubing (polyamide, polyurethane, FEP, polyethylene, etc.) from 4 mm to 16 mm diameter inclusive.

Replacement blades: part number 3000 71 00 05

A spring maintains the cutter in the closed position.

LIQUIfit® Push-In Fittings with Metal Adaptors

The LIQUIfit® range now benefits from a range extension of **metal adaptors** designed for **liquid transfer applications**. These fittings ensure **reliable** and **compact** connections combined with **excellent robustness**.

Product Advantages

Innovative Technology & Concept

Ergonomic and aesthetic design
Compact product for water applications
Easy-to-clean external surfaces
Full flow
Use with a pre-prepared metallic tubing
Gripping system preventing any pumping effect

Optimal Performance

Patented sealing technology
100% leak-tested in production
Date coding to guarantee quality and traceability
Wide range of shapes and numerous configurations
Excellent robustness for a long lifespan

High Performance Material

Bio-sourced polymer body meeting the most severe food process regulations
Compatibility with beverages (stainless steel version)
Unsurpassed chemical and mechanical resistance, even at high temperatures
Free of bisphenol A and phthalates, conforming with regulations



Industrial Fluids
Beverage Process
Inert Gases
Cooling Systems
Food Process

Applications

Technical Characteristics

Compatible Fluids	Water, beverages, industrial fluids: stainless steel threads Industrial fluids: FDA chemical nickel-plated brass threads					
Working Pressure	Vacuum to 16 bar					
Working Temperature	-10°C to +120°C up to 12 bar for O.D.4, 6 and 8 mm -10°C to +95°C for all other diameters					
Tightening Torques (BSPP)	Thread	M5 X0.8	G1/8	G1/4	G3/8	G1/2
	daN.m	0.16	0.8	1.2	3	3.5

Reliable performance is dependent upon the type of fluid conveyed, component materials and tubing being used.
Use is guaranteed with a vacuum of 755 mm Hg (99% vacuum).

Component Materials

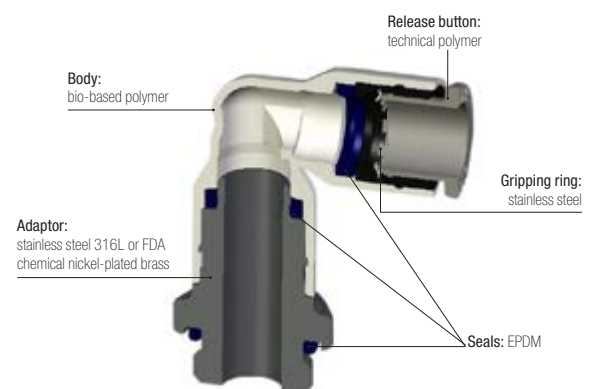

Silicone-free

Regulations

DI: 2002/95/EC (RoHS), 2011/65/EC
RG: 1935/2004/EC
FDA: 21 CFR
KTM (stainless steel only)
W270 (stainless steel only)

Stud Fittings with Stainless Steel Adaptor



6911 Stud Fitting, Male BSPP and Metric Thread



Stainless steel 316L, EPDM

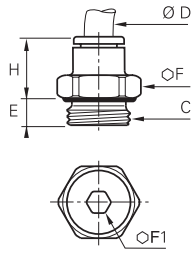

ØD	C		E	F	F1	H	Kg
4	M5x0.8	6911 04 19	3	10	2.5	14	0.006
	G1/8	6911 04 10	4.5	13	3	11.5	0.007
	G1/4	6911 04 13	5.5	16	3	10.5	0.011
6	M5x0.8	6911 06 19	3	10	2.5	16	0.005
	G1/8	6911 06 10	4.5	13	4	13	0.007
	G1/4	6911 06 13	5.5	16	4	12.5	0.011
8	G1/8	6911 08 10	4.5	13	5	20.5	0.011
	G1/4	6911 08 13	5.5	16	6	19.5	0.016
	G3/8	6911 08 17	5.5	21	6	18	0.022
10	G1/4	6911 10 13	5.5	16	7	23	0.018
	G3/8	6911 10 17	5.5	21	8	19.5	0.021
	G1/2	6911 10 21	7	24	8	18	0.033
12	G3/8	6911 12 17	5.5	21	9	27	0.029
	G1/2	6911 12 21	7	24	10	22.5	0.035
	G3/8	6911 16 17	7.5	27	9	32.5	0.060
16	G1/2	6911 16 21	9	27	12	32.5	0.063
	G3/4	6911 16 27	7.5	32	12	32.5	0.096

6975 Stud Fitting, Male BSPT Thread



Stainless steel 316L, EPDM

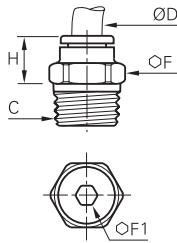

ØD	C		F	F1	H	Kg
4	R1/8	6975 04 10	10	3	9.5	0.005
	R1/4	6975 04 13	14	3	6.5	0.012
6	R1/8	6975 06 10	10	4	11.5	0.005
	R1/4	6975 06 13	14	4	8.5	0.011
8	R1/8	6975 08 10	13	5	20	0.011
	R1/4	6975 08 13	14	6	17	0.014
	R3/8	6975 08 17	17	6	13	0.021
10	R1/4	6975 10 13	16	7	20	0.017
	R3/8	6975 10 17	17	8	16.5	0.019
	R1/2	6975 10 21	21	8	14	0.037
12	R3/8	6975 12 17	19	9	24	0.028
	R1/2	6975 12 21	21	10	19.5	0.036

6959 Stud Elbow, Male BSPP and Metric Thread



Bio-based polymer, stainless steel 316L, EPDM

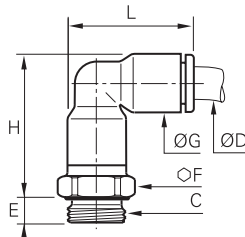

ØD	C		E	F	G	H	L	Kg
4	M5x0.8	6959 04 19	3.5	10	8.5	23	19	0.009
	G1/8	6959 04 10	4.5	13	8.5	22.5	19	0.009
	G1/4	6959 04 13	5.5	16	8.5	22.5	19	0.014
6	M5x0.8	6959 06 19	3.5	10	10.5	26.5	22.5	0.008
	G1/8	6959 06 10	4.5	13	10.5	26.5	22.5	0.011
	G1/4	6959 06 13	5.5	16	10.5	26.5	22.5	0.016
8	G1/8	6959 08 10	4.5	13	13.5	35	29.5	0.018
	G1/4	6959 08 13	5.5	16	13.5	33	29.5	0.020
	G3/8	6959 08 17	5.5	21	13.5	33	29.5	0.028
10	G1/4	6959 10 13	5.5	16	16	40.5	34	0.029
	G3/8	6959 10 17	5.5	21	16	39	34	0.037
	G1/2	6959 10 21	7	24	16	39	34	0.042
12	G3/8	6959 12 17	5.5	21	19	42	40	0.040
	G1/2	6959 12 21	7	24	19	42	40	0.049
	G3/8	6959 16 17	7.5	27	27	54	52	0.088
16	G1/2	6959 16 21	9	27	27	55	52	0.084
	G3/4	6959 16 27	10.5	32	27	55	52	0.120

6974 Stud Fitting, Female BSPP



Stainless steel 316L, EPDM

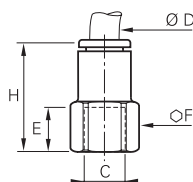

ØD	C		E	F	H	kg
16	G3/8	6974 16 17	17	27	44	0,060
	G1/2	6974 16 21	21.5	27	17	0,065
	G3/4	6974 16 27	19	32	47	0,097

Stud Fittings with Stainless Steel Adaptor,



6979 Stud Elbow, Male BSPT Thread



Bio-based polymer, stainless steel
316L, EPDM

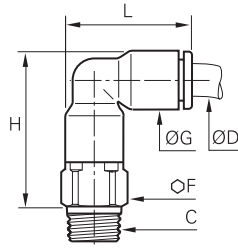

ØD	C		F	G	H	L	Kg
4	R1/8	6979 04 10	10	8.5	23	19	0.008
	R1/4	6979 04 13	14	8.5	23.5	19	0.018
6	R1/8	6979 06 10	10	10.5	27	22.5	0.010
	R1/4	6979 06 13	14	10.5	27.5	22.5	0.020
8	R1/8	6979 08 10	13	13.5	33.5	29.5	0.018
	R1/4	6979 08 13	14	13.5	32.5	29.5	0.022
10	R3/8	6979 08 17	17	13.5	33	29.5	0.032
	R1/4	6979 10 13	15	16	39.5	34	0.031
	R3/8	6979 10 17	17	16	39.5	34	0.041
12	R1/2	6979 10 21	21	16	39.5	34	0.060
	R3/8	6979 12 17	19	19	45.5	40.5	0.051
	R1/2	6979 12 21	21	19	45.5	40.5	0.065

Male Straight Push-In Fitting with Metal Adaptor

Dedicated for temperatures up to +150°C and 10 bar working pressure
FKM seal, FDA certification
Available on demand for O.D. 4 mm and 6 mm



+150°C

Working Temperature: -10°C to +120°C for O.D.4, 6 and 8 mm
-10°C to +95°C for all other diameters

Stud Fittings with FDA Chemical Nickel-Plated Brass Adaptor

6901 Stud Fitting, Male BSPP and Metric Thread



FDA chemical nickel-plated brass, EPDM

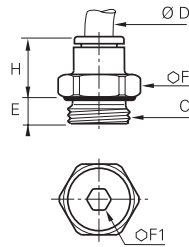

ØD	C		E	F	F1	H	kg
4	M5x0.8	6901 04 19	3	8	2.5	14	0.003
	G1/8	6901 04 10	5.5	13	3	11.5	0.007
6	M5x0.8	6901 06 19	3	10	2.5	16	0.005
	G1/8	6901 06 10	4.5	13	4	13	0.007
6	G1/4	6901 06 13	5.5	16	4	12.5	0.011
	G1/8	6901 08 10	4.5	13	5	20.5	0.011
8	G1/4	6901 08 13	5.5	16	6	19.5	0.016
	G3/8	6901 08 17	5.5	20	6	18	0.022
8	G1/4	6901 10 13	5.5	16	7	23	0.018
	G3/8	6901 10 17	5.5	20	8	19.5	0.021
10	G1/2	6901 10 21	7	24	8	18	0.033
	G1/2	6901 12 21	7	24	10	22.5	0.035

6905 Stud Fitting, Male BSPT Thread



FDA chemical nickel-plated brass, EPDM

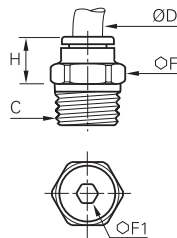

ØD	C		F	F1	H	kg
6	R1/8	6905 06 10	10	4	11.5	0.005
	R1/4	6905 06 13	14	4	8.5	0.011
6	R1/8	6905 08 10	13	5	20	0.011
	R1/4	6905 08 13	14	6	17	0.014
6	R3/8	6905 08 17	17	6	13	0.021
	R1/4	6905 10 13	16	7	20	0.017
10	R3/8	6905 10 17	17	8	16.5	0.019
	R3/8	6905 12 17	19	9	24	0.028
12	R1/2	6905 12 21	21	10	19.5	0.036

6999 Stud Elbow, Male BSPP and Metric Thread



Bio-based polymer, FDA chemical nickel-plated brass, EPDM

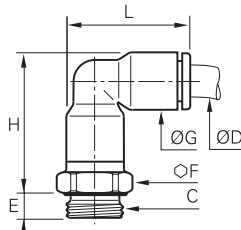

ØD	C		E	F	G	H	L	kg
4	M5x0.8	6999 04 19	3.5	8	8.5	23	19	0.005
	G1/8	6999 04 10	4.5	13	8.5	22.5	19	0.009
	G1/4	6999 04 13	5.5	16	8.5	22.5	19	0.014
6	M5x0.8	6999 06 19	3.5	10	10.5	26.5	22.5	0.008
	G1/8	6999 06 10	4.5	13	10.5	26.5	22.5	0.011
	G1/4	6999 06 13	5.5	16	10.5	26.5	22.5	0.016
6	G1/8	6999 08 10	4.5	13	13.5	35	29.5	0.018
	G1/4	6999 08 13	5.5	16	13.5	33	29.5	0.020
	G3/8	6999 08 17	5.5	20	13.5	33	29.5	0.028
10	G1/4	6999 10 13	5.5	16	16	40.5	34	0.029
	G3/8	6999 10 17	5.5	20	16	39	34	0.037
12	G3/8	6999 12 17	5.5	20	19	42	40	0.040
	G1/2	6999 12 21	7	24	19	42	40	0.049

The body swivels for positioning purposes.

6909 Stud Elbow, Male BSPT Thread



Bio-based polymer, FDA chemical nickel-plated brass, EPDM

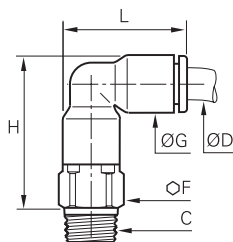

ØD	C		F	G	H	L	kg
6	R1/8	6909 06 10	10	10.5	27	22.5	0.010
8	R1/4	6909 08 13	14	13.5	32.5	29.5	0.022
10	R1/2	6909 10 21	21	16	39.5	34	0.060
12	R1/2	6909 12 21	21	19	45.5	40.5	0.065

The body swivels for positioning purposes.

Working Temperature: -10°C to +120°C for O.D.4, 6 and 8 mm
-10°C to +95°C for all other diameters

Advanced PE Tubing

Parker Legris **"Advanced PE" 50% reticulated** is designed for demanding environments, especially that of water treatment, without compromising operator **safety**.



Product Advantages

- Advanced PE**
- 50% reticulated material
 - Best balance between flexibility and pressure/temperature resistance
 - Resistant to a wide range of aggressive chemicals
 - UV-stabilised: ideal for outdoor applications
 - Approved for permanent contact with food and beverages
 - Silicone-free

Applications

- Beverage
- Chemical
- Petrochemical
- Food Process
- Water
- Water Treatment

Technical Characteristics

Compatible Fluids	Water, beverages and other fluids
Working Pressure	Vacuum to 16 bar
Working Temperature	-40°C to +95°C
Component Materials	High quality polyethylene: 50% reticulated PE

Regulations

Advanced PE Tubing

FDA: 21 CFR 177.1520
 RG: 1935/2004/EC
 DI: 97/23/EC (PED)
 DI: 2002/95/EC (RoHS), 2011/65/EC
 NSF 42/58 (1/4" and 3/8" approved for 10 bar and 1/2" approved for 8 bar at room temperature)
 NSF 51, 61 C-HOT
 ACS (except for purple colour)
 WRAS
 RG: 1907/2006 (REACH)
 NSF 42/58
 KTW
 W270

Reliable performance is dependent upon the type of fluid conveyed and fittings being used. Use is guaranteed with a vacuum of 755 mm Hg (99% vacuum).

Tubing Performance

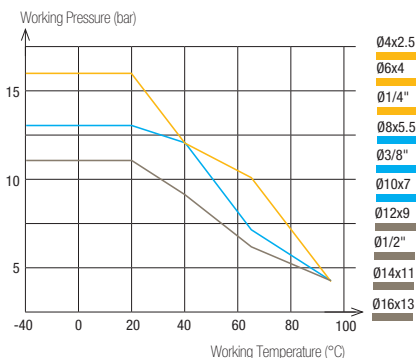

To calculate burst pressure, the values in these graphs should be multiplied by 3.

Tube O.D.	Tube O.D. Tolerance
1/4" to 1/2"	+0.10 / -0.10
4 to 16 mm	+0.10 / -0.10







Connected to Parker Legris push-in fittings, the calibration of Parker Legris tubing ensures perfect sealing.

Packaging

Drum: 150 m, 300 m
 250 feet, 500 feet, 1 000 feet







1015Y..F Advanced Polyethylene (APE) Tubing

Drum 150 m

Ø ext. (mm)	Ø int. (mm)		 clear					 white	kg
6	4	32	1015Y06F00	1015Y06F01			1015Y06F04	1015Y06F10	5.434
8	5.75	40	1015Y08F00	1015Y08F01	1015Y08F02	1015Y08F03	1015Y08F04	1015Y08F10	3.279
10	7	40	1015Y10F00	1015Y10F01	1015Y10F02	1015Y10F03	1015Y10F04	1015Y10F10	5.318







1030Y..F Advanced Polyethylene (APE) Tubing

Drum 300 m

Ø ext. (mm)	Ø int. (mm)		 clear					 white	kg
4	2.5	16	1030Y04F00	1030Y04F01					2.860
6	4	32	1030Y06F00	1030Y06F01	1030Y06F02	1030Y06F03	1030Y06F04	1030Y06F10	5.318





1075Y..F Advanced Polyethylene (APE) Tubing

Drum 75 m

Ø ext. (mm)	Ø int. (mm)		 clear					 white	kg
12	9	55	1075Y12F00	1075Y12F01	1075Y12F02	1075Y12F03	1075Y12F04	1075Y12F10	3.852
14	11	75	1075Y14F00						5.850
16	13	95	1075Y16F00						7.550



1096Y..F Advanced Polyethylene (APE) Tubing

Drum 250 ft

Ø ext. (inch)	Ø int. (inch)		 clear			kg
1/2	0.375	1.96	1096Y62F00	1096Y62F01	1096Y62F04	4.200

1098Y..F Advanced Polyethylene (APE) Tubing

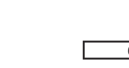
Drum 500 ft

Ø ext. (inch)	Ø int. (inch)		 clear			kg
1/4	0.170	0.78	1098Y56F00	1098Y56F01	1098Y56F04	2.334
3/8	0.250	1.18	1098Y60F00	1098Y60F01	1098Y60F04	5.518

PU Tubing

Polyurethane's **3 specific materials** - ether, ester and food-grade "crystal" - offer excellent flexibility and outstanding use in a wide range of applications, allowing for up to **50% space reduction** when compared to semi-rigid PA tubing.

Product Advantages

Excellent Mechanical Properties

- Consistent tensile strength for optimum longevity
- Optimal bend radius
- Good vibration absorption
- Unsurpassed abrasion resistance for a single layer tubing
- UV-resistant
- Superior vacuum capability due to surface hardness
- Remaining length marking
- Silicone-free

Ether Food-Grade Crystal

- Identification of fluids and circuits
- Chemical resistance superior to PU ether
- Improved longevity



- Applications**
- Food Process
 - Robotics
 - Cabling
 - Pneumatics
 - Automation
 - In-Plant Automotive
 - Rapid Cycles

Technical Characteristics

Compatible Fluids	Compressed air, industrial fluids (depending on the material type)
Working Pressure	Vacuum to 12 bar
Working Temperature	-20°C to +70°C
Component Materials	Polyurethane ether food-grade "crystal" (52 Shore D)

Regulations

Food (PU ether food-grade "crystal")
 FDA: 21 CFR 177.2600, 178.3297, 176.170, 178.2010
 RG: 1935/2004 EC

Reliable performance is dependent upon the type of fluid conveyed and fittings being used. Use is guaranteed with a vacuum of 755 mm Hg (99% vacuum).

Performance of PU Tubing

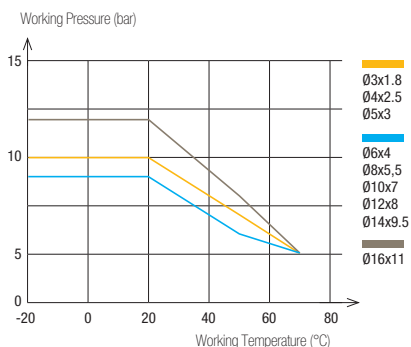

Tube O.D.	Tube O.D. Tolerance
3 to 8 mm	+0.10 / -0.10
10 to 16 mm	+0.15 / -0.15

Packaging





TubePack®: 25 m, 100 m
 Drum: 300 m, 500 m, 1 000 m

Connected to Parker Legris push-in fittings, the calibration of PU tubing ensures perfect sealing based on NF E49-101.

To calculate burst pressure, the values in this graph should be multiplied by 3.

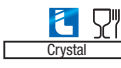



1025U..R Polyurethane (PU) Ether Tubing

Tubepack® 25 m

Ø ext. (mm)	Ø int. (mm)		 Crystal	 Crystal	 Crystal	 Crystal	 Crystal	kg
4	2.5	12	1025U04R08	1025U04R12	1025U04R13	1025U04R14	1025U04R17	0.310
5	3	13	1025U05R08					0.522
6	4	15	1025U06R08	1025U06R12	1025U06R13	1025U06R14	1025U06R17	0.591
8	5.5	20	1025U08R08	1025U08R12	1025U08R13	1025U08R14	1025U08R17	0.971
10	7	25	1025U10R08			1025U10R14		1.467
12	8	35	1025U12R08			1025U12R14		2.406
14	9.5	45						2.421
16	11	45	1025U16R08 11					2.815

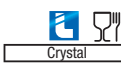

1100U..R Polyurethane (PU) Ether Tubing

Tubepack® 100 m

Ø ext. (mm)	Ø int. (mm)		 Crystal	 Crystal	 Crystal	 Crystal	 Crystal	kg
4	2.5	12	1100U04R08	1100U04R12	1100U04R13	1100U04R14	1100U04R17	1.092
6	4	15	1100U06R08	1100U06R12	1100U06R13	1100U06R14	1100U06R17	2.064
8	5.5	20	1100U08R08	1100U08R12	1100U08R13	1100U08R14	1100U08R17	3.610
10	7	25	1100U10R08			1100U10R14		6.109
12	8	35	1100U12R048					8.610
14	9.5	45	1100U14R08 95					11.215
16	11	45	1100U16R08 11					12.176



2003U..R Polyurethane (PU) Ether Tubing

Drum 300 m

Ø ext. (mm)	Ø int. (mm)		 Crystal	kg
10	7	25	2003U10R08	16.600



2005U..R Polyurethane (PU) Ether Tubing

Drum 500 m

Ø ext. (mm)	Ø int. (mm)		 Crystal	kg
8	5.5	20	2005U08R08	15.600

2010U..R Polyurethane (PU) Ether Tubing

Drum 1000 m

Ø ext. (mm)	Ø int. (mm)		 Crystal	kg
4	2.5	12	2010U04R08	8.670
6	4	15	2010U06R08	18.600

Fluoropolymer Tubing – FEP

FEP (fluorinated ethylene propylene) tubing is a **robust engineering fluoropolymer** which provides excellent fluid visibility and is perfect for flow control monitoring.

Product Advantages

Flow Control	Transparent Flexible and non-flammable material Resistant to nearly all chemicals and solvents
Tried-&-Tested Properties	Excellent transmission of UV light Low friction coefficient Food-grade material Low permeability Easily weldable Silicone-free



Applications

- Instrumentation
- Food Process
- UV
- Gas Sampling
- Chemical
- Temperature Cycling
- Laboratory

Technical Characteristics

Compatible Fluids	Industrial fluids
Working Pressure	0 to 28 bar Working pressure will depend on the type of fluid, temperature and fittings used. Please contact us for more information
Working Temperature	-40°C to +150°C
Component Materials	Fluorinated ethylene propylene (pure) (55 Shore D)

Reliable performance is dependent upon the type of fluid conveyed and fittings being used.

Regulations

Food
FDA: 21 CFR 177.1550

Available upon request:
FDA NSF
RG 1935/2004
EU 10/2011

Dimensions and Tolerances

Tube O.D.	Tube O.D. Tolerance
4 mm	+0.05 / -0.05
6 to 10 mm	+0.07 / -0.07
12 mm	+0.10 / -0.10



Packaging
Tubepack®: 5 m, 25 m

Connected to Parker Legris push-in fittings, the calibration of Parker Legris tubing ensures perfect sealing.

1005T

Fluoropolymer (FEP) Tubing



Tubepack® 5 m

Ø ext. (mm)	Ø int. (mm)	 R	 clear	kg
4	2.5	40	1005T04 00 25	0.155
6	4	50	1005T06 00	0.250
8	6	70	1005T08 00	0.385
10	8	120	1005T10 00	0.524
12	10	180	1005T12 00	0.547

1025T

Fluoropolymer (FEP) Tubing

Tubepack® 25 m

Ø ext. (mm)	Ø int. (mm)	 R	 clear	kg
4	2.5	40	1025T04 00 25	0.506
6	4	50	1025T06 00	1.025
8	6	70	1025T08 00	1.431
10	8	120	1025T10 00	1.693
12	10	180	1025T12 00	1.913

LIQUIfit® Non-Return Valves

LIQUIfit® non-return valves meet the requirements for conveying **beverages**. They allow flow in one direction and prevent any return flow. Fitted in the circuit, they provide **total protection**.

Product Advantages

Suitable for Beverage Applications

- Fully compatible for use with water, beverages and liquid foodstuffs (liquids and gas)
- Very low cracking threshold
- Excellent chemical compatibility
- Resistant to cleaning products
- Hygienic design with smooth surfaces
- Fluid direction indicated
- EPDM sealing technology



Water Softeners
Water Treatment
Water Purification
Drinks Dispensers
Hot & Cold Water Systems

Applications

Technical Characteristics

Compatible Fluids	Water, beverages, liquid foodstuffs
Working Pressure	1 to 10 bar
Working Temperature	1°C to +65°C
Cracking Pressure	0.02 bar up to O.D. 3/8" 0.03 bar for O.D. 1/2"

Component Materials

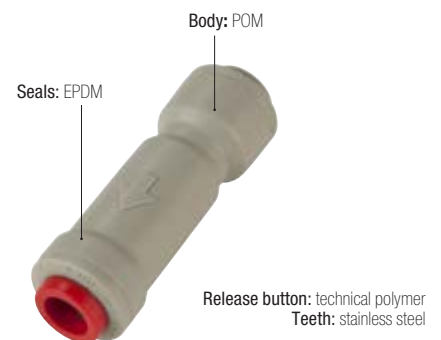

Silicone-free

Regulations

DI: 2002/95/EC (RoHS), 2011/65/EC
FDA: 21 CFR 177.1550
NSF 51
RG: 1907/2006 (REACH)

LIQUIfit® Non-Return Valves

7992 Single Non-Return Valve



POM, EPDM

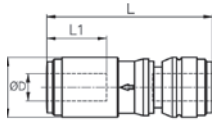

ØD		G	L	L1	kg
6	7992 06 00WP2	15.5	45.5	16	0.007
8	7992 08 00WP2	17.5	48.5	17.5	0.010
10	7992 10 00WP2	20	57.5	19	0.014
12	7992 12 00WP2	23.5	67.5	24	0.022

7992 Single Non-Return Valve



Inch



POM, EPDM

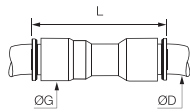

ØD		G	L	kg
1/4	7992 56 00WP2	17	51	0.008
3/8	7992 60 00WP2	20	55	0.011
1/2	7992 62 00WP2	25	68	0.015

5/16" also available = 7992 08 00WP2 above

LIQUIfit® Ball Valves

This range of valves offers an innovative solution in the treatment of **water and the handling of beverages** while protecting **health**. These **compact and reliable** valves offer perfect **sealing** and excellent **cleanliness**.

Product Advantages

Innovative Technology & Increased Reliability

- Full flow to limit turbulence
- Full-flow self-cleaning ball maintains the cleanliness of the circuit
- Tube retention with gripping ring prevents pumping effect
- Push-in connection and disconnection
- Sealing technology using patented EPDM seal

High Performance

- Inert technical polymer providing the best mechanical strength, thermal and chemical resistance
- Carstick® connection providing resistance to water hammer
- Other configurations available on request



Beverage Dispensers
Inert Gases
Cooling
Food Process
Water Purification
Water Coolers

Applications

Technical Characteristics

Compatible Fluids	Water, drinks, beverages		
Working Pressure	0 to 10 bar at 20°C		
Working Temperature	-15°C to +100°C		
Tightening Torques	Threads	1/4" NPTF	3/8" NPTF
	daN.m	1.5	3

Component Materials

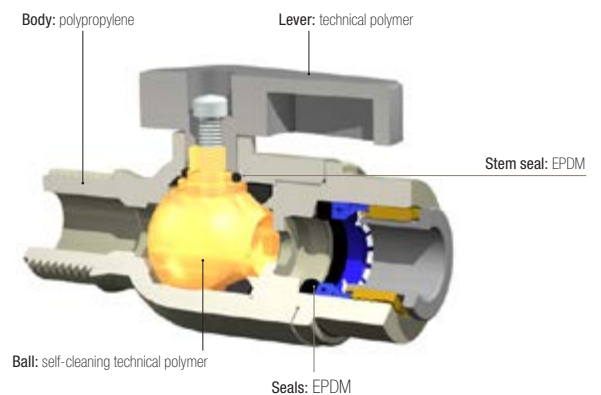

Silicone-free

Regulations

FDA: 21 CFR
NSF: 51
WQA: Water Quality Association
RG: 1907/2006 (REACH)

LIQUIfit® Ball Valves

4020 2/2 In-Line Ball Valve

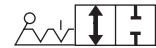

Polypropylene with fibreglass, EPDM

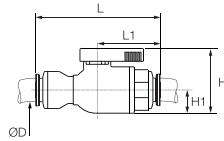

ØD		H	H1	L	L1	Kg
6	4020 06 00WP2	36	13	57	27	0.019
8	4020 08 00WP2	36	13	60	27	0.020
10	4020 10 00WP2	36	13	70	33	0.023
12	4020 12 00WP2	36.5	13	88	43	0.034

4020 2/2 In-Line Ball Valve



Polypropylene with fibreglass, EPDM

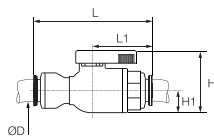

ØD		H	H1	L	L1	Kg
1/4	4020 56 00WP2	25	13	65	31	0.025
3/8	4020 60 00WP2	36	13	68	30.5	0.034

4021 2/2 In-Line Ball Valve, Male NPTF Thread



Polypropylene with fibreglass, EPDM

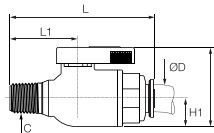

ØD	C		H	H1	L	L1	Kg
1/4	NPTF1/4	4021 56 14WP2	36	13	61	31	0.029
3/8	NPTF3/8	4021 60 18WP2	36	13	64	33.5	0.028

4023 2/2 In-Line Ball Valve, Female NPTF Thread



Polypropylene with fibreglass, EPDM

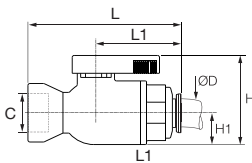

ØD	C		H	H1	L	L1	Kg
3/8	NPTF3/8	4023 60 18WP2	36	13	64	33.5	0.028

4022 2/2 Right- Angled Ball Valve, Female NPTF Thread

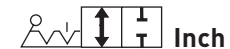

Polypropylene with fibreglass, EPDM

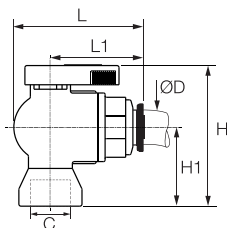

ØD	C		H	H1	L	L1	Kg
1/4	NPTF1/4	4022 56 14WP2	52	29	44	31	0.026

4024 2/2 Right- Angled Ball Valve



Polypropylene with fibreglass, EPDM

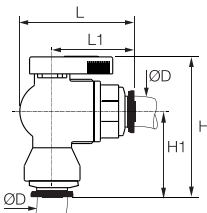

ØD		H	H1	L	L1	Kg
6	4024 06 00WP2	54	31	41	27	0.020
8	4024 08 00WP2	56	33	41	27.5	0.020
10	4024 10 00WP2	61	38	47	33	0.024
12	4024 12 00WP2	63	40	57	43	0.031



Parker Legris :

Connecting You to the Best in Technology
Master Catalogue



ENGINEERING YOUR SUCCESS.



Parker's Motion & Control Technologies

At Parker, we're guided by a relentless drive to help our customers become more productive and achieve higher levels of profitability by engineering the best systems for their requirements. It means looking at customer applications from many angles to find new ways to create value. Whatever the motion and control technology need, Parker has the experience, breadth of product and global reach to consistently deliver. No company knows more about motion and control technology than Parker. For further info call 00800 27 27 5374



Aerospace

Key Markets

Aftermarket services
Commercial transports
Engines
General & business aviation
Helicopters
Launch vehicles
Military aircraft
Missiles
Power generation
Regional transports
Unmanned aerial vehicles

Key Products

Control systems & actuation products
Engine systems & components
Fluid conveyance systems & components
Fluid metering, delivery & atomization devices
Fuel systems & components
Fuel tank inerting systems
Hydraulic systems & components
Thermal management
Wheels & brakes



Climate Control

Key Markets

Agriculture
Air conditioning
Construction Machinery
Food & beverage
Industrial machinery
Life sciences
Oil & gas
Precision cooling
Process
Refrigeration
Transportation

Key Products

Accumulators
Advanced actuators
CO₂ controls
Electronic controllers
Filter driers
Hand shut-off valves
Heat exchangers
Hose & fittings
Pressure regulating valves
Refrigerant distributors
Safety relief valves
Smart pumps
Solenoid valves
Thermostatic expansion valves



Electromechanical

Key Markets

Aerospace
Factory automation
Life science & medical
Machine tools
Packaging machinery
Paper machinery
Plastics machinery & converting
Primary metals
Semiconductor & electronics
Textile
Wire & cable

Key Products

AC/DC drives & systems
Electric actuators, gantry robots & slides
Electrohydraulic actuation systems
Electromechanical actuation systems
Human machine interface
Linear motors
Stepper motors, servo motors, drives & controls
Structural extrusions



Filtration

Key Markets

Aerospace
Food & beverage
Industrial plant & equipment
Life sciences
Marine
Mobile equipment
Oil & gas
Power generation & renewable energy
Process
Transportation
Water Purification

Key Products

Analytical gas generators
Compressed air filters & dryers
Engine air, coolant, fuel & oil filtration systems
Fluid condition monitoring systems
Hydraulic & lubrication filters
Hydrogen, nitrogen & zero air generators
Instrumentation filters
Membrane & fiber filters
Microfiltration
Sterile air filtration
Water desalination & purification filters & systems



Fluid & Gas Handling

Key Markets

Aerial lift
Agriculture
Bulk chemical handling
Construction machinery
Food & beverage
Fuel & gas delivery
Industrial machinery
Life sciences
Marine
Mining
Mobile
Oil & gas
Renewable energy
Transportation

Key Products

Check valves
Connectors for low pressure fluid conveyance
Deep sea umbilicals
Diagnostic equipment
Hose couplings
Industrial hose
Mooring systems & power cables
PTFE hose & tubing
Quick couplings
Rubber & thermoplastic hose
Tube fittings & adapters
Tubing & plastic fittings

Hydraulics

Key Markets

Aerial lift
Agriculture
Alternative energy
Construction machinery
Forestry
Industrial machinery
Machine tools
Marine
Material handling
Mining
Oil & gas
Power generation
Refuse vehicles
Renewable energy
Truck hydraulics
Turf equipment

Key Products

Accumulators
Cartridge valves
Electrohydraulic actuators
Human machine interfaces
Hybrid drives
Hydraulic cylinders
Hydraulic motors & pumps
Hydraulic systems
Hydraulic valves & controls
Hydrostatic steering
Integrated hydraulic circuits
Power take-offs
Power units
Rotary actuators
Sensors

Pneumatics

Key Markets

Aerospace
Conveyor & material handling
Factory automation
Life science & medical
Machine tools
Packaging machinery
Transportation & automotive

Key Products

Air preparation
Brass fittings & valves
Manifolds
Pneumatic accessories
Pneumatic actuators & grippers
Pneumatic valves & controls
Quick disconnects
Rotary actuators
Rubber & thermoplastic hose & couplings
Structural extrusions
Thermoplastic tubing & fittings
Vacuum generators, cups & sensors

Process Control

Key Markets

Alternative fuels
Biopharmaceuticals
Chemical & refining
Food & beverage
Marine & shipbuilding
Medical & dental
Microelectronics
Nuclear Power
Offshore oil exploration
Oil & gas
Pharmaceuticals
Power generation
Pulp & paper
Steel
Water/wastewater

Key Products

Analytical Instruments
Analytical sample conditioning products & systems
Chemical injection fittings & valves
Fluoropolymer chemical delivery fittings, valves & pumps
High purity gas delivery fittings, valves, regulators & digital flow controllers
Industrial mass flow meters/controllers
Permanent no-weld tube fittings
Precision industrial regulators & flow controllers
Process control double block & bleeds
Process control fittings, valves, regulators & manifold valves

Sealing & Shielding

Key Markets

Aerospace
Chemical processing
Consumer
Fluid power
General industrial
Information technology
Life sciences
Microelectronics
Military
Oil & gas
Power generation
Renewable energy
Telecommunications
Transportation

Key Products

Dynamic seals
Elastomeric o-rings
Electro-medical instrument design & assembly
EMI shielding
Extruded & precision-cut, fabricated elastomeric seals
High temperature metal seals
Homogeneous & inserted elastomeric shapes
Medical device fabrication & assembly
Metal & plastic retained composite seals
Shielded optical windows
Silicone tubing & extrusions
Thermal management
Vibration dampening

ENGINEERING YOUR SUCCESS.

Parker Worldwide

Europe, Middle East, Africa

AE – United Arab Emirates,

Dubai
Tel: +971 4 8127100
parker.me@parker.com

AT – Austria, Wiener Neustadt

Tel: +43 (0)2622 23501-0
parker.austria@parker.com

AT – Eastern Europe, Wiener

Neustadt
Tel: +43 (0)2622 23501 900
parker.easteurope@parker.com

AZ – Azerbaijan, Baku

Tel: +994 50 2233 458
parker.azerbaijan@parker.com

BE/LU – Belgium, Nivelles

Tel: +32 (0)67 280 900
parker.belgium@parker.com

BG – Bulgaria, Sofia

Tel: +359 2 980 1344
parker.bulgaria@parker.com

BY – Belarus, Minsk

Tel: +48 (0)22 573 24 00
parker.poland@parker.com

CH – Switzerland, Etoy

Tel: +41 (0)21 821 87 00
parker.switzerland@parker.com

CZ – Czech Republic, Klecany

Tel: +420 284 083 111
parker.czechrepublic@parker.com

DE – Germany, Kaarst

Tel: +49 (0)2131 4016 0
parker.germany@parker.com

DK – Denmark, Ballerup

Tel: +45 43 56 04 00
parker.denmark@parker.com

ES – Spain, Madrid

Tel: +34 902 330 001
parker.spain@parker.com

FI – Finland, Vantaa

Tel: +358 (0)20 753 2500
parker.finland@parker.com

FR – France, Contamine s/Arve

Tel: +33 (0)4 50 25 80 25
parker.france@parker.com

GR – Greece, Piraeus

Tel: +30 210 933 6450
parker.greece@parker.com

HU – Hungary, Budaörs

Tel: +36 23 885 470
parker.hungary@parker.com

IE – Ireland, Dublin

Tel: +353 (0)1 466 6370
parker.ireland@parker.com

IL – Israel

Tel: +39 02 45 19 21
parker.israel@parker.com

IT – Italy, Corsico (MI)

Tel: +39 02 45 19 21
parker.italy@parker.com

KZ – Kazakhstan, Almaty

Tel: +7 7273 561 000
parker.easteurope@parker.com

NL – The Netherlands, Oldenzaal

Tel: +31 (0)541 585 000
parker.nl@parker.com

NO – Norway, Asker

Tel: +47 66 75 34 00
parker.norway@parker.com

PL – Poland, Warsaw

Tel: +48 (0)22 573 24 00
parker.poland@parker.com

PT – Portugal

Tel: +351 22 999 7360
parker.portugal@parker.com

RO – Romania, Bucharest

Tel: +40 21 252 1382
parker.romania@parker.com

RU – Russia, Moscow

Tel: +7 495 645-2156
parker.russia@parker.com

SE – Sweden, Spånga

Tel: +46 (0)8 59 79 50 00
parker.sweden@parker.com

SK – Slovakia, Banská Bystrica

Tel: +421 484 162 252
parker.slovakia@parker.com

SL – Slovenia, Novo Mesto

Tel: +386 7 337 6650
parker.slovenia@parker.com

TR – Turkey, Istanbul

Tel: +90 216 4997081
parker.turkey@parker.com

UA – Ukraine, Kiev

Tel: +48 (0)22 573 24 00
parker.poland@parker.com

UK – United Kingdom, Warwick

Tel: +44 (0)1926 317 878
parker.uk@parker.com

ZA – South Africa, Kempton Park

Tel: +27 (0)11 961 0700
parker.southafrica@parker.com

North America

CA – Canada, Milton, Ontario

Tel: +1 905 693 3000

US – USA, Cleveland

Tel: +1 216 896 3000

Asia Pacific

AU – Australia, Castle Hill

Tel: +61 (0)2-9634 7777

CN – China, Shanghai

Tel: +86 21 2899 5000

HK – Hong Kong

Tel: +852 2428 8008

IN – India, Mumbai

Tel: +91 22 6513 7081-85

JP – Japan, Tokyo

Tel: +81 (0)3 6408 3901

KR – South Korea, Seoul

Tel: +82 2 559 0400

MY – Malaysia, Shah Alam

Tel: +60 3 7849 0800

NZ – New Zealand, Mt Wellington

Tel: +64 9 574 1744

SG – Singapore

Tel: +65 6887 6300

TH – Thailand, Bangkok

Tel: +662 186 7000

TW – Taiwan, Taipei

Tel: +886 2 2298 8987

South America

AR – Argentina, Buenos Aires

Tel: +54 3327 44 4129

BR – Brazil, Sao Jose dos Campos

Tel: +55 800 727 5374

CL – Chile, Santiago

Tel: +56 2 623 1216

MX – Mexico, Toluca

Tel: +52 72 2275 4200

European Product Information Centre

Free phone: 00 800 27 27 5374

(from AT, BE, CH, CZ, DE, DK, EE, ES, FI,
FR, IE, IL, IS, IT, LU, MT, NL, NO, PL, PT, RU,
SE, SK, UK, ZA)

