

Overview



Keep flexible - with the universal SITRANS TR200 transmitter

- 2-wire device for 4 to 20 mA
- Enclosure for rail mounting
- Universal input for virtually any type of temperature sensor
- Configurable over PC

Benefits

- Compact design
- Galvanic isolation
- Test sockets for multimeters
- Diagnostics LED (green/red)
- Sensor monitoring open circuits and short-circuits
- Self-monitoring
- Configuration status stored in EEPROM
- Expanded diagnostic functions, such as slave pointer, operating hours counter, etc.
- Special characteristic
- Electromagnetic compatibility to EN 61326 and NE21
- SIL2 (with order note C20), SIL2/3 (with C23)

Application

SITRANS TR200 transmitters can be used in all industrial sectors. Their compact design enables simple mounting on standard DIN rails on-site in protective boxes or in control cabinets. The following sensors/signal sources can be connected over their universal input module:

- Resistance thermometer (2, 3, 4-wire connection)
- Thermocouples
- Resistance-based sensors and DC voltage sources

The output signal is a direct current from 4 to 20 mA in accordance with the sensor characteristic.

Transmitters of the "intrinsically safe" type of protection can be installed within potentially explosive atmospheres. The devices meet the directive 2014/34/EU (ATEX).

Function

The SITRANS TR200 is configured over a PC. For this purpose, the USB or RS 232 modem is connected to the output terminals. The configuration data can now be edited using the SIPROM T software tool. The configuration data are then permanently stored in the non-volatile memory (EEPROM).

Once the sensors and power supply have been correctly connected, the transmitter outputs a temperature-linear output signal and the diagnostics LED displays a green light. In the case of a sensor break, the LED flashes red, an internal device fault is indicated by a steady red light.

The test socket can be used to connect an ammeter at any time for monitoring purposes and plausibility checks. The output current can be read without any interruption, or even without opening the current loop.

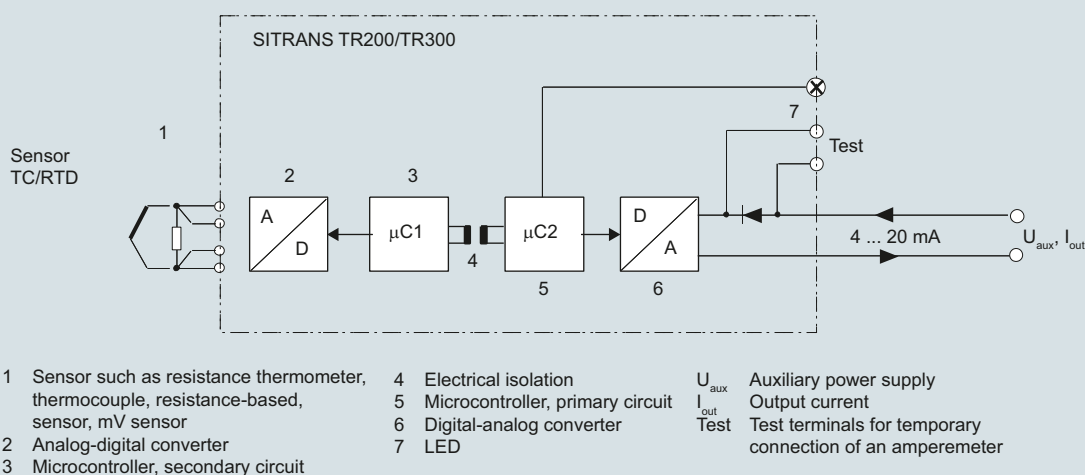

SITRANS TR200 function diagram

Temperature measurement

Temperature transmitters

Rail transmitters

SITRANS TR200 (4 to 20 mA, universal)

Technical specifications

Input

Resistance thermometer

Measured variable	Temperature
Sensor type	Pt25 ... Pt1000 Pt25 ... Pt1000 Ni25 ... Ni1000 Via special characteristic (max. 30 points)
• According to IEC 60751	
• Acc. to JIS C 1604; $a=0.00392 \text{ K}^{-1}$	
• According to IEC 60751	
• Special type	
Sensor factor	0.25 ... 10 (adaptation of the basic type, e.g. Pt100 to version Pt25 ... 1000)
Units	°C or °F
Connection	
• Standard connection	1 resistance thermometer (RTD) in 2-wire, 3-wire or 4-wire connection
• Averaging	2 resistance thermometers in 2-wire connection for generation of average temperature
• Differentiation	2 resistance thermometers (RTD) in 2-wire connection (RTD 1 – RTD 2 or RTD 2 – RTD 1)
Connection	
• 2-wire connection	Line resistance can be configured $\leq 100 \Omega$ (loop resistance)
• 3-wire connection	No trim necessary
• 4-wire connection	No trim necessary
Sensor current	$\leq 0.45 \text{ mA}$
Response time T_{63}	$\leq 250 \text{ ms}$ for 1 sensor with break monitoring
Break monitoring	Always active (cannot be switched off)
Short-circuit monitoring	Can be switched on/off (default value: ON)
Measuring range	Assignable (see "Digital measuring error" table)
Min. measuring span	10 °C (18 °F)
Characteristic curve	Temperature-linear or special characteristic

Resistance-based sensor

Measured variable	Actual resistance
Sensor type	Resistance-based, potentiometers
Units	Ω
Connection	
• Standard connection	1 resistance-based sensor (R) in 2-wire, 3-wire or 4-wire connection
• Averaging	2 resistance-based sensors in 2-wire connection for averaging
• Differentiation	2 resistance thermometers in 2-wire connection (R1 – R2 or R2 – R1)
Connection	
• 2-wire connection	Line resistance can be configured $\leq 100 \Omega$ (loop resistance)
• 3-wire connection	No trim necessary
• 4-wire connection	No trim necessary
Sensor current	$\leq 0.45 \text{ mA}$
Response time T_{63}	$\leq 250 \text{ ms}$ for 1 sensor with break monitoring
Break monitoring	Always active (cannot be switched off)
Short-circuit monitoring	Can be switched on/off (default value: OFF)
Measuring range	Assignable max. 0 ... 2200 Ω (see "Digital measuring error" table)
Min. measuring span	5 ... 25 Ω (see "Digital measuring error" table)
Characteristic curve	Resistance-linear or special characteristic

Thermocouples

Measured variable	Temperature
Sensor type (thermocouples)	Pt30Rh-Pt6Rh acc. to IEC 584 W5%-Re acc. to ASTM 988 W3%-Re acc. to ASTM 988 NiCr-CuNi acc. to IEC 584 Fe-CuNi acc. to IEC 584 NiCr-Ni acc. to IEC 584 Fe-CuNi acc. to DIN 43710 NiCrSi-NiSi acc. to IEC 584 Pt13Rh-Pt acc. to IEC 584 Pt10Rh-Pt acc. to IEC 584 Cu-CuNi acc. to IEC 584 Cu-CuNi acc. to DIN 43710
• Type B	
• Type C	
• Type D	
• Type E	
• Type J	
• Type K	
• Type L	
• Type N	
• Type R	
• Type S	
• Type T	
• Type U	
Units	°C or °F
Connection	
• Standard connection	1 thermocouple (TC)
• Averaging	2 thermocouples (TC)
• Differentiation	2 thermocouples (TC) (TC1 – TC2 or TC2 – TC1)
Response time T_{63}	$\leq 250 \text{ ms}$ for 1 sensor with break monitoring
Break monitoring	Can be switched off
Reference junction compensation	
• Internal	With integrated Pt100 resistance thermometer
• External	With external Pt100 IEC 60751 (2-wire or 3-wire connection) Reference junction temperature can be set as fixed value
• External fixed	
Measuring range	Assignable (see "Digital measuring error" table)
Min. measuring span	Min. 40 ... 100 °C (72 ... 180 °F) (see "Digital measuring error" table)
Characteristic curve	Temperature-linear or special characteristic

mV sensor

Measured variable	DC voltage
Sensor type	DC voltage source (DC voltage source possible over an externally connected resistor)
Units	mV
Response time T_{63}	$\leq 250 \text{ ms}$ for 1 sensor with break monitoring
Break monitoring	Can be switched off
Measuring range	Assignable max. -100 ... 1100 mV
Min. measuring span	2 mV or 20 mV
Overload capability of the input	-1.5 ... +3.5 V DC
Input resistance	$\geq 1 \text{ M}\Omega$
Characteristic curve	Voltage-linear or special characteristic

Output	
Output signal	4 ... 20 mA, 2-wire
Auxiliary power	11 ... 35 V DC (to 30 V with Ex i/ic; to 32 V with Ex nA)
Max. load	($U_{aux} - 11$ V)/0.023 A
Overrange	3.6 ... 23 mA, infinitely adjustable (default range: 3.84 mA ... 20.5 mA)
Error signal (e.g. following sensor fault) (conforming to NE43)	3.6 ... 23 mA, infinitely adjustable (default value: 22.8 mA)
Sample cycle	0.25 s nominal
Damping	Software filter 1st order 0 ... 30 s (parameterizable)
Protection	Against reverse polarity
Galvanic isolation	Input against output 2.12 kV DC (1.5 kV _{rms} AC)
Measuring accuracy	
Digital measuring error	See "Digital measuring error" table
Reference conditions	
• Auxiliary power	24 V ± 1 %
• Load	500 Ω
• Ambient temperature	23 °C
• Warming-up time	> 5 min
Error in the analog output (digital/analog converter)	< 0.025 % of measuring span
Error due to internal reference junction	< 0.5 °C (0.9 °F)
Effect of ambient temperature	
• Analog measuring error	0.02 % of meas. span/10 °C (18 °F)
• Digital measuring error	
- With resistance thermometer	0.06 °C (0.11 °F)/10 °C (18 °F)
- With thermocouples	0.6 °C (1.1 °F)/10 °C (18 °F)
Auxiliary power effect	< 0.001 % of meas. span/V
Effect of load impedance	< 0.002 % of meas. span/100 Ω
Long-term drift	
• In the first month	< 0.02 % of measuring span
• After one year	< 0.2 % of measuring span
• After 5 years	< 0.3 % of measuring span
Rated conditions	
<u>Ambient conditions</u>	
Ambient temperature	-40 ... +85 °C (-40 ... +185 °F)
Storage temperature	-40 ... +85 °C (-40 ... +185 °F)
Relative humidity	< 98 %, with condensation
Electromagnetic compatibility	According to EN 61326 and NE21
Design	
Material	Plastic, electronic module potted
Weight	122 g
Dimensions	See "Dimensional drawings"
Cross-section of cables	Max. 2.5 mm ² (AWG 13)
Degree of protection according to IEC 60529	
• Enclosure	IP20

Certificates and approvals

Explosion protection ATEX

EC type-examination certificate

- "Intrinsic safety" type of protection

PTB 07 ATEX 2032X

II 2(1) G Ex ia/ib IIC T6/T4

II 3(1) G Ex ia/ic IIC T6/T4

II 3 G Ex ic IIC T6/T4

II 2(1) D Ex iaD/ibD 20/21 T115 °C

II 3 G Ex nA IIC T6/T4

- "Non-sparking equipment" type of protection

Other certificates

NEPSI and EAC Ex

Software requirements for SIPROM T

PC operating system

Windows ME, 2000, XP, Win 7 and Win 8; in connection with RS 232 modem, also Windows 95, 98 and 98SE

Factory setting:

- Pt100 (IEC 751); 3-wire connection
- Measuring range: 0 ... 100 °C (32 ... 212 °F)
- Fault current: 22.8 mA
- Sensor offset: 0 °C (0 °F)
- Damping 0.0 s

Temperature measurement

Temperature transmitters
Rail transmitters

SITRANS TR200 (4 to 20 mA, universal)

Digital measuring error

Resistance thermometer

Input	Measuring range	Minimum measuring span		Digital accuracy	
		°C (°F)	°C (°F)	°C (°F)	°C (°F)
According to IEC 60751					
Pt25	-200 ... +850 (-328 ... +1562)	10	(18)	0.3	(0.54)
Pt50	-200 ... +850 (-328 ... +1562)	10	(18)	0.15	(0.27)
Pt100 ... Pt200	-200 ... +850 (-328 ... +1562)	10	(18)	0.1	(0.18)
Pt500	-200 ... +850 (-328 ... +1562)	10	(18)	0.15	(0.27)
Pt1000	-200 ... +350 (-328 ... +662)	10	(18)	0.15	(0.27)
According to JIS C1604-81					
Pt25	-200 ... +649 (-328 ... +1200)	10	(18)	0.3	(0.54)
Pt50	-200 ... +649 (-328 ... +1200)	10	(18)	0.15	(0.27)
Pt100 ... Pt200	-200 ... +649 (-328 ... +1200)	10	(18)	0.1	(0.18)
Pt500	-200 ... +649 (-328 ... +1200)	10	(18)	0.15	(0.27)
Pt1000	-200 ... +350 (-328 ... +662)	10	(18)	0.15	(0.27)
Ni 25 ... Ni1000	-60 ... +250 (-76 ... +482)	10	(18)	0.1	(0.18)

Resistance-based sensor

Input	Measuring range	Minimum measuring span	Digital accuracy
			Ω
Resistance	0 ... 390	5	0.05
Resistance	0 ... 2200	25	0.25

Thermocouples

Input	Measuring range	Minimum measuring span		Digital accuracy	
		°C (°F)	°C (°F)	°C (°F)	°C (°F)
Type B	100 ... 1820 (212 ... 3308)	100	(180)	2 ¹⁾	(3.6) ¹⁾
Type C (W5)	0 ... 2300 (32 ... 4172)	100	(180)	2	(3.6)
Type D (W3)	0 ... 2300 (32 ... 4172)	100	(180)	1 ²⁾	(1.8) ²⁾
Type E	-200 ... +1000 (-328 ... +1832)	50	(90)	1	(1.8)
Type J	-200 ... +1200 (-328 ... +2192)	50	(90)	1	(1.8)
Type K	-200 ... +1370 (-328 ... +2498)	50	(90)	1	(1.8)
Type L	-200 ... +900 (-328 ... +1652)	50	(90)	1	(1.8)
Type N	-200 ... +1300 (-328 ... +2372)	50	(90)	1	(1.8)
Type R	-50 ... +1760 (-58 ... +3200)	100	(180)	2	(3.6)
Type S	-50 ... +1760 (-58 ... +3200)	100	(180)	2	(3.6)
Type T	-200 ... +400 (-328 ... +752)	40	(72)	1	(1.8)
Type U	-200 ... +600 (-328 ... +1112)	50	(90)	2	(3.6)

¹⁾ The digital accuracy in the range 100 to 300 °C (212 to 572 °F) is 3 °C (5.4 °F).

²⁾ The digital accuracy in the range 1750 to 2300 °C (3182 to 4172 °F) is 2 °C (3.6 °F).

mV sensor

Input	Measuring range	Minimum measuring span	Digital accuracy
			μV
mV sensor	-10 ... +70	2	40
mV sensor	-100 ... +1100	20	400

The digital accuracy is the accuracy after the analog/digital conversion including linearization and calculation of the measured value.

An additional error is generated in the output current 4 to 20 mA as a result of the digital/analog conversion of 0.025% of the set measuring span (digital-analog error).

The total error under reference conditions at the analog output is the sum from the digital error and the digital-analog error (poss. with the addition of reference junction errors in the case of thermocouple measurements).

Selection and ordering data

	Article No.
SITRANS TR200 rail transmitter Installation on mounting rail 2-wire system, 4 to 20 mA, programmable, with galvanic isolation	
• Without explosion protection	7NG3032-0JN00
• With explosion protection according to ATEX	7NG3032-1JN00
Options	Order code
Append suffix "-Z" to article no., add order code and plain text, if applicable.	
With test report (5 measuring points)	C11
Functional safety SIL2	C20
Functional safety SIL2/3	C23
Customer-specific programming	
Measuring range to be set	Y01¹⁾
Specify in plain text (max. 5 digits): Y01:... to ... °C, °F	
Measuring point number (TAG) max. 8 characters	Y17²⁾
Measuring point description, max. 16 characters	Y23²⁾
Measuring point message, max. 32 characters	Y24²⁾
Text on front plate, max. 16 characters	Y29²⁾³⁾
Pt100 (IEC) 2-wire, R _L = 0 W	U02⁴⁾
Pt100 (IEC) 3-wire	U03⁴⁾
Pt100 (IEC) 4-wire	U04⁴⁾
Type B thermocouple	U20⁴⁾⁵⁾
Type C thermocouple (W5)	U21⁴⁾⁵⁾
Type D thermocouple (W3)	U22⁴⁾⁵⁾
Type E thermocouple	U23⁴⁾⁵⁾
Type J thermocouple	U24⁴⁾⁵⁾
Type K thermocouple	U25⁴⁾⁵⁾
Type L thermocouple	U26⁴⁾⁵⁾
Type N thermocouple	U27⁴⁾⁵⁾
Type R thermocouple	U28¹⁾⁴⁾⁵⁾
Type S thermocouple	U29⁴⁾⁵⁾
Type T thermocouple	U30⁴⁾⁵⁾
Type U thermocouple	U31⁴⁾⁵⁾
For TC: Cold junction compensation: external (Pt100, 3-wire)	U41
For TC: Reference junction compensation: external with fixed value: specify in plain text	Y50
Enter special deviating customer-specific setting in plain text	Y09⁶⁾
Fault current 3.6 mA (instead of 22.8 mA)	U36²⁾

- 1) For customer-specific programming for RTD and TC, the start value and the end value of the required measuring span must be specified here.
- 2) For this selection, Y01 or Y09 must also be selected.
- 3) Text on front plate is not saved in the device.
- 4) For this selection, Y01 must also be selected.
- 5) Internal reference junction compensation is selected as the default for TC.
- 6) For customer-specific programming for mV and ohm, the start value and the end value of the required measuring span and the unit must be entered here.

Accessories

	Article No.
Additional accessories for assembly, connection and transmitter configuration, see page 2/251.	
Modem Modem with USB interface and SIPROM T software	7NG3092-8KN

For supply units, see Catalog FI01 section "Supplementary components"

Ordering example 1:

7NG3032-0JN00-Z Y01+Y17+Y29+U03

Y01: -10 ... +100 °C

Y17: TICA123

Y29: TICA123

Ordering example 2:

7NG3032-0JN00-Z Y01+Y17+Y23+Y29+U25

Y01: -10 ... +100 °C

Y17: TICA123

Y23: TICA123HEAT

Y29: TICA123HEAT

Factory setting:

- Pt100 (IEC 751); 3-wire connection
- Measuring range: 0 ... 100 °C (32 ... 212 °F)
- Fault current: 22.8 mA
- Sensor offset: 0 °C (0 °F)
- Damping 0.0 s

Temperature measurement

Temperature transmitters

Rail transmitters

SITRANS TR200 (4 to 20 mA, universal)

Dimensional drawings

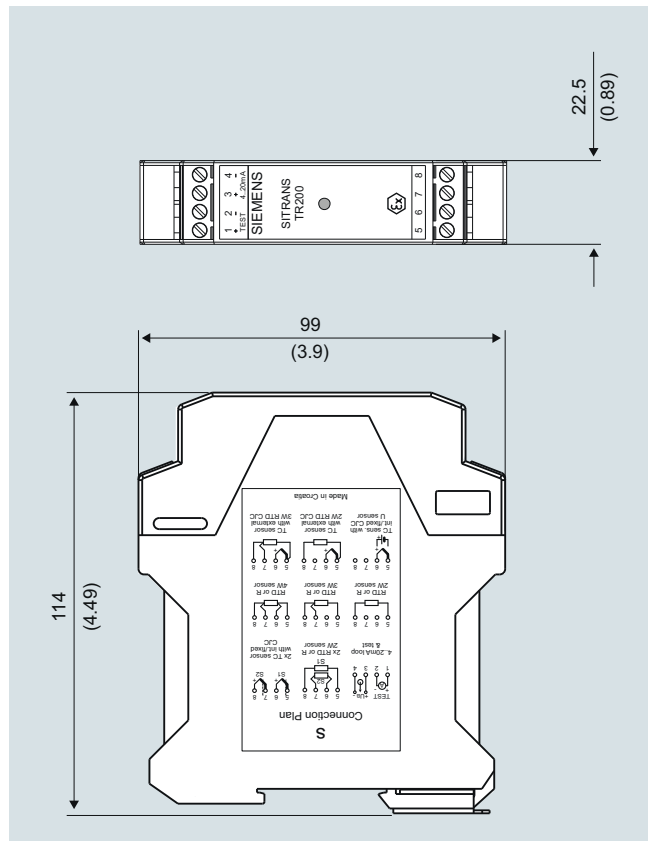

SITRANS TR200, dimensions in mm (inch)

Circuit diagrams

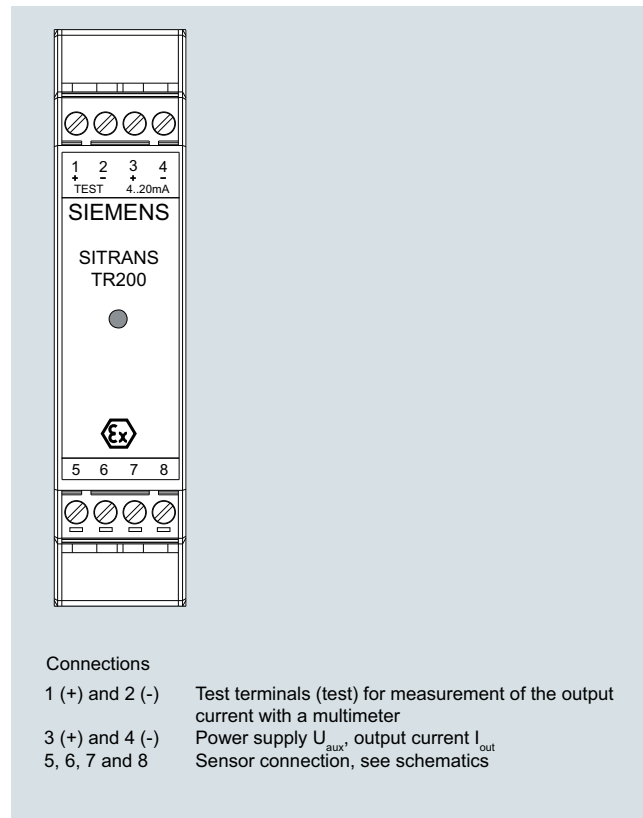

SITRANS TR200, connector assignment

Resistance thermometer

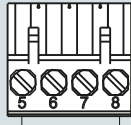

2-wire system ¹⁾

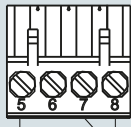

3-wire system

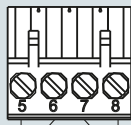

4-wire system

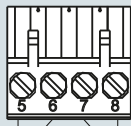

Generation of average value/difference ¹⁾

¹⁾ Programmable line resistance for the purpose of correction.

Resistance

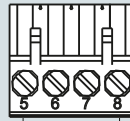

2-wire system ¹⁾

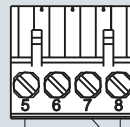

3-wire system

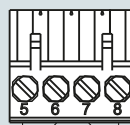

4-wire system

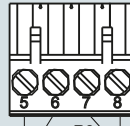

Generation of average value/difference ¹⁾

Thermocouple

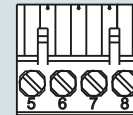

Cold junction compensation internal/fixed value

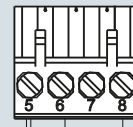

Cold junction compensation with external Pt100 in 2-wire system ¹⁾

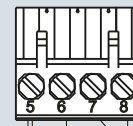

Cold junction compensation with external Pt100 in 3-wire system

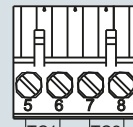

Generation of average value / difference with internal cold junction compensation

Voltage measurement

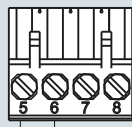

Current measurement

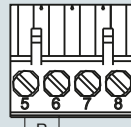

Test terminals

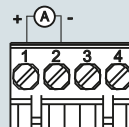

Power supply/
4 ... 20 mA (U_{aux})

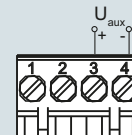

SITRANS TR200, sensor connection assignment